

PORTFOLIO TUTORIAL!

BRIDGE

06
20
23

TUES, JUNE 20
@ 1-2 PM
ECLASSROOM

PART 1:
COMPONENTS

ALL WELCOME
(BUT, ESPECIALLY 2B & AE!)

WITH DANI
& MAGDALENA

BRIDGE

Introductions:



Dani Grabke

- M3
- 2022 B. Arch graduate
- Might also know me as BRIDGE director or seen climbing!



Magdalena Kaczmarczyk

- M3
- 2021 B. Arch graduate
- Might also know me as galt. Co-Editor-in-Chief or seen longboard dancing!

Agenda:

- Brief overview of an Architecture portfolio
- Deep Dive:
 - CV
 - Reference Letters
 - Academic Projects
 - Professional Work
 - Personal Work
- Tips & Tricks & Best Practices:
 - Portfolio Curation
 - Redoing a Project
 - Publishing on Issuu
 - Page size & limits
 - File size management
 - InDesign Tips
 - Things to Avoid

Cover Page

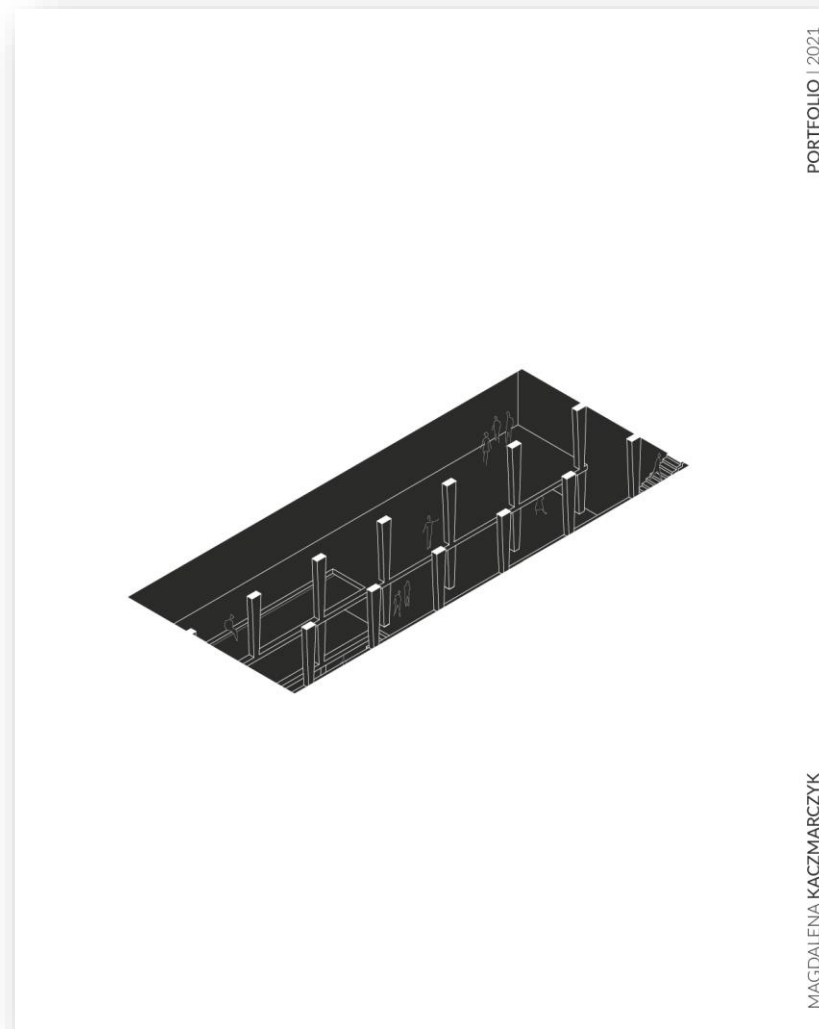

Contents:

- Cover Page



Hi! 

My name is Magdalena Kaczmarczyk.

I am a graduate of the **University of Waterloo School of Architecture's** Bachelor Program.

I am goal-oriented, curious, and an organization wizard. With almost 2 years of architecture internship positions and additional freelancing experience, I have been expanding my knowledge of what architecture can affect while keeping an open and critical mind. I am eager to start this next step in my architecture journey with your firm!

#(647) 209-2807 @m2kaczma@uwaterloo.ca

EDUCATION.

BACHELOR OF ARCHITECTURAL STUDIES
2016 – 2021.
University of Waterloo

EXPERIENCE.

FREELANCE DESIGNER

Jan – Apr 2021, Sept 2021 – present.
Creative Designer.
+ Clients: Blimp Homes Inc., Independent Clients
+ Programs used: Photoshop, Illustrator, After Effects, Procreate

B+H | TORONTO, ON.

Jan – Aug 2020
Architectural Assistant.
+ Worked on 0-50% and 50-75% Construction Documents for architecture and interior design projects.
+ Collaborated in small teams to complete competition projects.
+ Programs used: Revit, Vray, Illustrator, Photoshop, Rhinoceros.

ECDM | PARIS, FRANCE.

May – July 2019.
Architectural Assistant.
+ Worked on Competition entries and Design Development projects. Modified several presentation renders to updated with most concurrent design, used the laser cutter to create a model of project in a short time frame.
+ Programs used: Autocad, V-Ray, Indesign, Photoshop, Illustrator, Rhinoceros, Sketchup.

NBBJ | NEW YORK CITY, NY.

Sept – Dec 2018.
Architectural Assistant.
+ Worked with Revit to work on 75-100% Construction Documents, used Indesign and Illustrator to create Indesign templates for presentation use.
+ Programs used: Revit, Indesign, Illustrator

IAN MACLAREN ARCHITECT INC. | OAKVILLE, ON.

Jan – Apr 2018.
Architectural Design Assistant.
+ Worked on 3D modeling to present views to clients, designed accessory buildings, learned and collected zoning by-laws, modified plans according to provided instruction.
+ Programs used: Sketchup, Autocad, Photoshop

DISTINCTIONS.

galt. PUBLICATIONS | DIGITAL MEDIA & EDITORIAL DESIGNER
Issue 04 | Sept 2020 – Nov 2021.

NON-ARCHITECTURE | "HEALING" COMPETITION FINALIST
2020.

PRESIDENT'S INTERNATIONAL EXPERIENCE AWARD
2019.

WATERLOO ARCHITECTURE | ADMISSIONS INTERVIEWER
April 2019.

CISC ARCHITECTURE | COMPETITION FINALIST (TOP 10)
2017.

WATERLOO ORIENTATION | "HUGE" ORIENTATION LEADER
2017.

Contents:

- Cover Page
- CV

table of contents.

To Whom It May Concern,

My name is Stephen Mylenski. I am a Senior Project Architect with NBBJ architecture firm out of New York City. I am writing to you in reference to the work of Magdalena Kaczmarczyk. Magdalena was an intern this summer and fall at NBBJ New York. She worked under my supervision on our office's Coney Island Hospital project, a 450,000 SF replacement hospital for Coney Island Hospital.

Magdalena worked on Construction Documents for us. She was given a wide range of tasks including finish plans and elevations, toilet accessory population, partition type and location documentation, power-data plan documentation, medical and specialty equipment documentation, and graphic cleanup of the set.

Magdalena worked in Revit 2017 and was able to expediently pick up many tasks presented to her. She worked very hard on all her tasks and always asked the right questions. She meticulously performed tasks and kept a written log with any questions or comments she had, and made sure to address each one. She always made a point to understand the full task and when the task needed to be completed by.

Magdalena was a joy to have on our team, and earned the respect of all team members that worked with her. I personally, enjoyed Magdalena's pleasant demeanor, diligent work ethic and ability to rise to any task. I would fully recommend her for employment and would think any firm that hired Magdalena would benefit greatly from her work.

Sincerely,

Stephen Mylenski, RA, LEED AP BD+C Associate / Project Architect
NBBJ 140 Broadway 29th Floor NEW YORK NY 10005
Direct: 212.739.7240
www.nbbj.com / [@nbbjdesign](https://www.instagram.com/nbbjdesign) / <http://meanstheworld.co>



all roads lead to *roam*. 06

villa-kiosk. 16

lungs of steel 20

r(ev)amp 28

crystalline 38

personal(ity) 54

05

Contents:

- Cover Page
- CV
- Reference Letters
- Table of Contents

all roads lead to roam.

FOURTH YEAR EXHIBITION

🕒 4 MONTHS
🏢 4B RESEARCH / STUDIO
👤 GROUP W/ E.ZHANG

Urban growth is inevitable. The Waterloo region is no stranger to exponential growth in economy and population. In the past five years, the region has seen a population increase of 51,000 resulting to around 600,000 residents – and is projected to house over 950,000 by 2051. Kitchener, at the heart of the growth, has neglected its cultural and public spaces – weakening its cultural identity, and conceding to inflexible developments. There is a need for thoughtful, public-focused, at-ground design and intervention for cultural enrichment in the soon-to-be powerhouse city.

The Victoria Street corridor in Kitchener offers a rich opportunity for growth and urban intensification. Its industrial roots and centralized location present potential for not only the built-up environment, but also for responsible open spaces. It is ideally located to serve as a connective spine to multiple districts, forming a strong network of downtown circulation. Through critical analysis, and with a series of design interventions, there exists a version of Victoria Street where it grows as a walkable, safe, and an iconic city organ built for the people.

A joint research project with Ethan Zhang, all roads lead to roam, is an analytical look into the future of the currently neglected Victoria Street in downtown Kitchener, including research into its future conditions and advocating for responsible at-ground design.



FOURTH YEAR EXHIBITION

07

all roads lead to roam.

Contents:

- Cover Page
- CV
- Reference Letters
- Table of Contents
- Academic Work

- 🕒 2ND YEAR – CURRENT
- 📁 PERSONAL/PROFESSIONAL WORK
- 👤 INDIVIDUAL

Additional selected works. Contains professional work from previous internship positions varying from 2018-2020, on projects I had participated on and my responsibilities within each role. For a more detailed description of my responsibilities, please refer to my portfolio.

In addition to my professional work, included are personal projects taken up for my self interest.

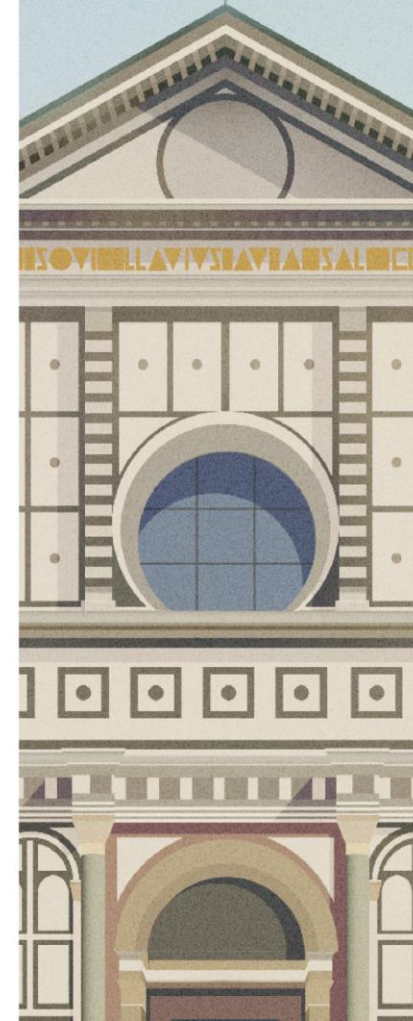

Contents:

- Cover Page
- CV
- Reference Letters
- Table of Contents
- Academic Work
- Personal Work



64

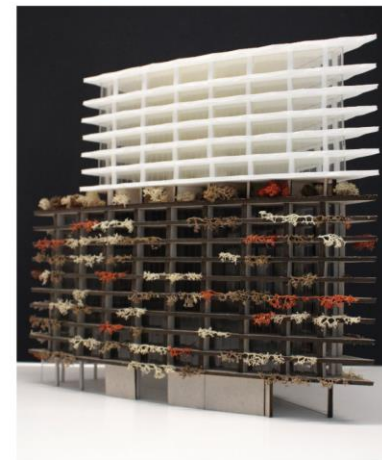
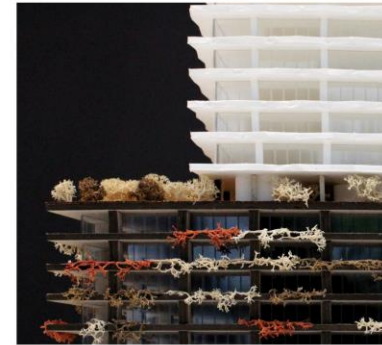

65

BOULOGNE PROJECT COMPETITION, WIP
Boulogne is a mixed use residential office building competition entry, a collaboration with **Chartier Dalix and Bjarke Ingels Group**. Using the perspective renders (seen left) and plans as reference, a maquette was created using digital fabrication methods.

E C D M

Contents:

- Cover Page
- CV
- Reference Letters
- Table of Contents
- Academic Work
- Personal Work
- Professional Work

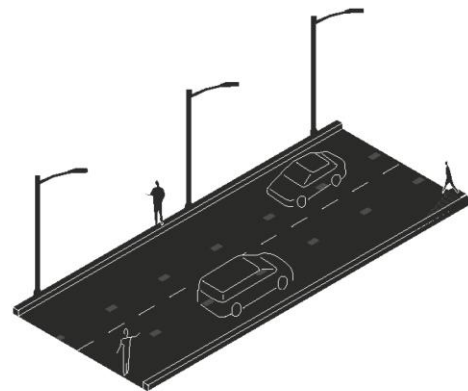

thank you.

#(647) 209-2807 @m2kaczma@uwaterloo.ca

Contents:

- Cover Page
- CV
- Reference Letters
- Table of Contents
- Academic Work
- Personal Work
- Professional Work
- End Page
With contact info!

Deep Dive:

- CV
- CV to Resume
- Academic Projects & Competitions
- Professional Work
- Personal Projects

Danielle V. Grabke

Tel: (647)-515-7706
Email: dvgrabke@edu.uwaterloo.ca
Address: Toronto, ON

Skills

Software

Adobe Creative Suite (Photoshop, Illustrator, InDesign, LightRoom, Premiere),
Rhinceros5, VRay, Grasshopper, Maxwell
Render, Microsoft Office (Word, Excel,
Power Point, Access, OneNote, Outlook)

Fabrication

Physical Modeling, Hand Drafting,
Laser Cutting, CNC Milling,
3D Printing, Woodworking

Business

Sales, Customer Service, Public Speaking,
Marketing, Money Handling

Languages

English & French (Bilingual)
Mandarin (Basic)

Experience

Sales Lead | 04.2018 – Present | Journeys | Toronto and Kitchener, ON

Provide customers with an excellent shopping experience and represent the company in a friendly, professional manner. Enriching personal skills in customer service, patience, hard-work, and cooperation.

Class Representative | 09.2018 – Present | Waterloo Architecture Students Association | Cambridge, ON

I am the main channel for communication between my class and the faculty. I voice my class' concerns, suggestions, and questions regarding our education and experience at the university.

Social Media Coordinator & Authour | 01.2018 – Present | BRIDGE | Cambridge, ON

BRIDGE Waterloo Architecture is an organization that engages the students of the University of Waterloo School of Architecture and the community of Cambridge through both a digital and physical presence in the promotion of architecture and design. As an Authour, I publish articles. As the Social Media Coordinator, I plan, post, and monitor BRIDGE's Facebook and Instagram to maximize views.

Orientation Leader | 04.2018 - 09.2018 | University of Waterloo | Cambridge, ON

Created, organized, and ran events throughout Orientation week for the incoming first years to feel welcomed to our campus and encourage long-lasting friendships to form. As a HUGE, I had more responsibilities throughout the Spring term to plan Orientation week.

President of Marketing | 09.2016 – 05.2017 | Jardin | Toronto, ON

Led the marketing team of our Central Ontario Junior Achievement company to learn how to run a business, empower others, and be socially responsible. Through the process of product fabrication, marketing, and selling, our company was nominated for nine awards, one of which was for my leadership in marketing.

Education

Bachelor of Architectural Studies Honors Co-Op | 2017-Present
University of Waterloo
Cambridge, ON N1S 2H4

Ontario Secondary School Diploma | 2014-2017

York Mills Collegiate Institute
Toronto, ON M3B 1W6
- French Immersion Certificate
- Ontario Scholar with 4-year Honor Roll Status
- Merit Scholarship

Interests

Sports: Cross Country | Swimming
Media: Photography | Image & Video Editing
Dancing: Bachata | Salsa | Hip Hop
Music: Violin | Singing
Social Media: Instagram | Facebook

Danielle V. Grabke

Tel: (647)-515-7706
Email: dvgrabke@edu.uwaterloo.ca
Address: Toronto, ON

Skills

Software

Adobe Creative Suite (Photoshop, Illustrator, InDesign, LightRoom, Premiere), Rhinoceros5, V-Ray, Grasshopper, Maxwell Render, Microsoft Office (Word, Excel, Power Point, Access, OneNote, Outlook)

Business

Sales, Customer Service, Public Speaking, Marketing, Money Handling

Fabrication

Physical Modeling, Hand Drafting, Laser Cutting, CNC Milling, 3D Printing, Woodworking

Languages

English & French (Bilingual), Mandarin (Basic)

Experience

Sales Lead | 04.2018 – Present | Journeys | Toronto and Kitchener, ON

Provide customers with an excellent shopping experience and represent the company in a friendly, professional manner. Enriching personal skills in customer service, patience, hard-work, and cooperation.

Class Representative | 09.2018 – Present | Waterloo Architecture Students Association | Cambridge, ON

I am the main channel for communication between my class and the faculty. I voice my class' concerns, suggestions, and questions regarding our education and experience at the university.

Social Media Coordinator & Author | 01.2018 – Present | BRIDGE | Cambridge, ON

BRIDGE Waterloo Architecture is an organization that engages the students of the University of Waterloo School of Architecture and the community of Cambridge through both a digital and physical presence in the promotion of architecture and design. As an Author, I publish articles. As the Social Media Coordinator, I plan, post, and monitor BRIDGE's Facebook and Instagram to maximize views.

Orientation Leader | 04.2018 - 09.2018 | University of Waterloo | Cambridge, ON

Created, organized, and ran events throughout Orientation week for the incoming first years to feel welcomed to our campus and encourage long-lasting friendships to form. As a HUGE, I had more responsibilities throughout the Spring term to plan Orientation week.

President of Marketing | 09.2016 – 05.2017 | Jardín | Toronto, ON

Led the marketing team of our Central Ontario Junior Achievement company to learn how to run a business, empower others, and be socially responsible. Through the process of product fabrication, marketing, and selling, our company was nominated for nine awards, one of which was for my leadership in marketing.

Education

Bachelor of Architectural Studies Honors Co-Op | 2017-Present

University of Waterloo
Cambridge, ON N1S 2H4

Ontario Secondary School Diploma | 2014-2017

York Mills Collegiate Institute
Toronto, ON M3B 1W6

- French Immersion Certificate
- Ontario Scholar with 4-year Honor Roll Status
- Merit Scholarship

Interests

Sports: Cross Country | Swimming

Media: Photography | Image & Video Editing

Dancing: Bachata | Salsa | Hip Hop

Music: Violin | Singing

Social Media: Instagram | Facebook

- Address not necessary

1st Year CV: Improvements Needed



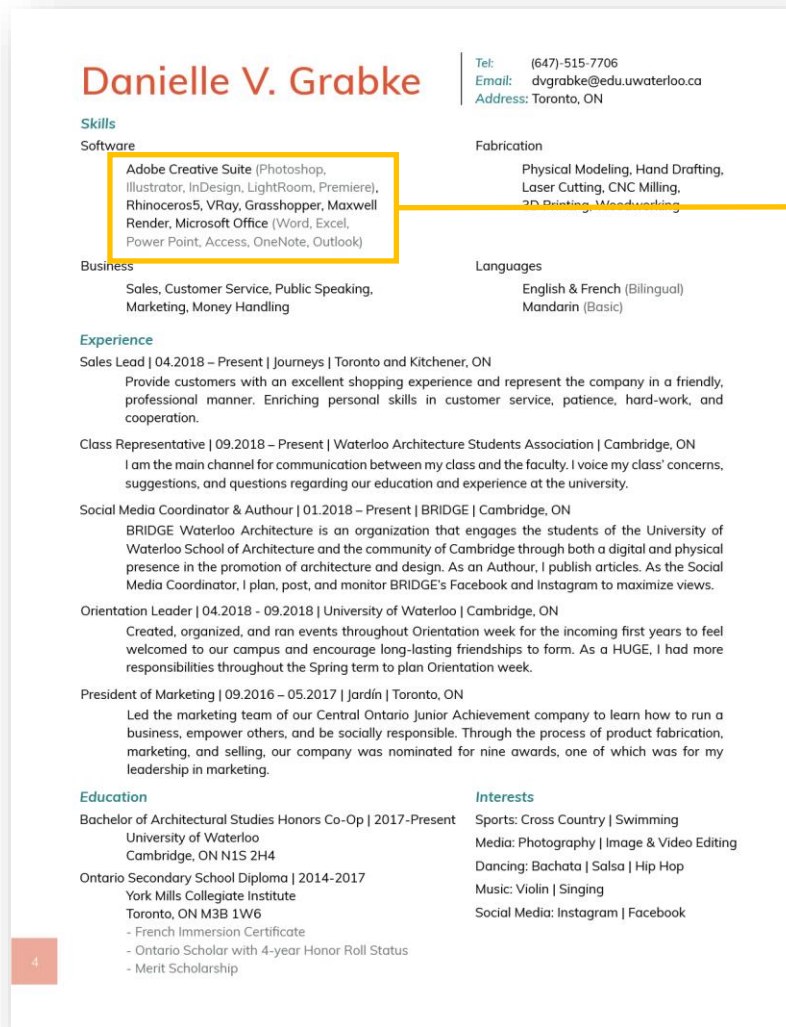

- Unclear; remember they only spend a few seconds scanning through your resume!

1st Year CV: Improvements Needed



Danielle V. Grabke

Tel: (647)-515-7706
Email: dvgrabke@edu.uwaterloo.ca
Address: Toronto, ON

Skills

Software

Adobe Creative Suite (Photoshop, Illustrator, InDesign, LightRoom, Premiere), Rhinoceros5, V-Ray, Grasshopper, Maxwell Render, Microsoft Office (Word, Excel, Power Point, Access, OneNote, Outlook)

Fabrication

Physical Modeling, Hand Drafting, Laser Cutting, CNC Milling, 3D Printing, Woodworking

Business

Sales, Customer Service, Public Speaking, Marketing, Money Handling

Languages

English & French (Bilingual), Mandarin (Basic)

Experience

Sales Lead | 04.2018 – Present | Journeys | Toronto and Kitchener, ON

Provide customers with an excellent shopping experience and represent the company in a friendly, professional manner. Enriching personal skills in customer service, patience, hard-work, and cooperation.

Class Representative | 09.2018 – Present | Waterloo Architecture Students Association | Cambridge, ON

I am the main channel for communication between my class and the faculty. I voice my class' concerns, suggestions, and questions regarding our education and experience at the university.

Social Media Coordinator & Author | 01.2018 – Present | BRIDGE | Cambridge, ON

BRIDGE Waterloo Architecture is an organization that engages the students of the University of Waterloo School of Architecture and the community of Cambridge through both a digital and physical presence in the promotion of architecture and design. As an Author, I publish articles. As the Social Media Coordinator, I plan, post, and monitor BRIDGE's Facebook and Instagram to maximize views.

Orientation Leader | 04.2018 - 09.2018 | University of Waterloo | Cambridge, ON

Created, organized, and ran events throughout Orientation week for the incoming first years to feel welcomed to our campus and encourage long-lasting friendships to form. As a HUGE, I had more responsibilities throughout the Spring term to plan Orientation week.

President of Marketing | 09.2016 – 05.2017 | Jardín | Toronto, ON

Led the marketing team of our Central Ontario Junior Achievement company to learn how to run a business, empower others, and be socially responsible. Through the process of product fabrication, marketing, and selling, our company was nominated for nine awards, one of which was for my leadership in marketing.

Education

Bachelor of Architectural Studies Honors Co-Op | 2017-Present

University of Waterloo
Cambridge, ON N1S 2H4

Ontario Secondary School Diploma | 2014-2017

York Mills Collegiate Institute
Toronto, ON M3B 1W6

- French Immersion Certificate
- Ontario Scholar with 4-year Honor Roll Status
- Merit Scholarship

Interests

Sports: Cross Country | Swimming

Media: Photography | Image & Video Editing

Dancing: Bachata | Salsa | Hip Hop

Music: Violin | Singing

Social Media: Instagram | Facebook

- Not enough hierarchy

1st Year CV: Improvements Needed



Danielle V. Grabke

Tel: (647)-515-7706
Email: dvgrabke@edu.uwaterloo.ca
Address: Toronto, ON

Skills

Software

Adobe Creative Suite (Photoshop, Illustrator, InDesign, LightRoom, Premiere), Rhinoceros5, V-Ray, Grasshopper, Maxwell Render, Microsoft Office (Word, Excel, Power Point, Access, OneNote, Outlook)

Fabrication

Physical Modeling, Hand Drafting, Laser Cutting, CNC Milling, 3D Printing, Woodworking

Business

Sales, Customer Service, Public Speaking, Marketing, Money Handling

Languages

English & French (Bilingual)
Mandarin (Basic)

Experience

Sales Lead | 04.2018 – Present | Journeys | Toronto and Kitchener, ON

Provide customers with an excellent shopping experience and represent the company in a friendly, professional manner. Enriching personal skills in customer service, patience, hard-work, and cooperation.

Class Representative | 09.2018 – Present | Waterloo Architecture Students Association | Cambridge, ON

I am the main channel for communication between my class and the faculty. I voice my class' concerns, suggestions, and questions regarding our education and experience at the university.

Social Media Coordinator & Author | 01.2018 – Present | BRIDGE | Cambridge, ON

BRIDGE Waterloo Architecture is an organization that engages the students of the University of Waterloo School of Architecture and the community of Cambridge through both a digital and physical presence in the promotion of architecture and design. As an Author, I publish articles. As the Social Media Coordinator, I plan, post, and monitor BRIDGE's Facebook and Instagram to maximize views.

Orientation Leader | 04.2018 - 09.2018 | University of Waterloo | Cambridge, ON

Created, organized, and ran events throughout Orientation week for the incoming first years to feel welcomed to our campus and encourage long-lasting friendships to form. As a HUGE, I had more responsibilities throughout the Spring term to plan Orientation week.

President of Marketing | 09.2016 – 05.2017 | Jardín | Toronto, ON

Led the marketing team of our Central Ontario Junior Achievement company to learn how to run a business, empower others, and be socially responsible. Through the process of product fabrication, marketing, and selling, our company was nominated for nine awards, one of which was for my leadership in marketing.

Education

Bachelor of Architectural Studies Honors Co-Op | 2017-Present

University of Waterloo
Cambridge, ON N1S 2H4

Ontario Secondary School Diploma | 2014-2017

York Mills Collegiate Institute
Toronto, ON M3B 1W6
- French Immersion Certificate
- Ontario Scholar with 4-year Honor Roll Status
- Merit Scholarship

Interests

Sports: Cross Country | Swimming
Media: Photography | Image & Video Editing
Dancing: Bachata | Salsa | Hip Hop
Music: Violin | Singing
Social Media: Instagram | Facebook

Nice to have:

- Personal Interests! Adds character and something to talk about at the interview.



📧 dvrgrabke@uwaterloo.ca
📞 647-515-7706

Hello! I'm Dani,

Work Experience

- Jan. 2022 – Apr. 2022** **MGBA**
Vancouver, BC
Architectural Intern
 - Developed Rezoning and Development Permit drawing packages for a new condo, including calculating FSR, iterating massing models, and drawing unit plans.
 - Created Revit models from scratch
- Jan. 2021 – Aug. 2021** **Architecture49**
Montréal, QC
Étudiante en Architecture
 - Worked fluently in French.
 - Solely responsible for modeling a major industrial building in Revit.
 - BIM (Building Information Modeling) and data manager for cost estimating.
 - Collaborated with architects and six teams of engineering consultants.
- Sept. 2019 – Dec. 2019** **HLW**
New York, NY
Interior Design Intern
 - Worked on SD, DD, and CA phases on office renovation projects.
 - Built Revit models from CAD drawings, drew construction details, and made Enscape renders
 - Compiled furniture bid packages and finish sample boards for clients.
- Jan. 2019 – Apr. 2019** **Architecture 49**
Toronto, ON
Architectural Assistant
 - Rendered images in Vray for transportation projects.
 - Developed an Accessibility for Ontarians with Disabilities Act (AODA) Compliance Checklist.
 - Held meetings with product and material representatives.

Relevant Skills

| Software | Fabrication | Languages |
|--------------------------|-------------------|------------------|
| Revit | Physical Modeling | English (fluent) |
| Enscape | Hand Drafting | French (working) |
| Rhinoceros | Laser Cutting | |
| Vray | CNC Milling | |
| AutoCAD | 3D Printing | |
| SketchUp | Woodworking | |
| Adobe Ps, Ai, Id, Lr, Pr | | |

Education

- Sept. 2022 – Present** **University of Waterloo**
Cambridge, ON
Master of Architecture
- Sept. 2017 – Aug. 2022** **University of Waterloo**
Cambridge, ON
Bachelor of Architectural Studies Honors Co-Op

Leadership Involvement

- Sept. 2022 – Present** **BRIDGE Centre for Architecture + Design**
Cambridge, ON
Director
 - Coordinate, structure, organize, and run the student-run initiative striving to bridge the gap between the School of Architecture and the community of Cambridge, ON.
- Sept. 2022 – Present** **Mentorship for Architecture Peers**
Cambridge, ON
Mentor
 - Discuss academic and professional matters, recommend and refer them to campus resources, and promote healthy mentalities toward school.
 - Mentoring 1 group of first-year undergraduate and 1 group of first-year graduate students to aid their transition into the Waterloo Architecture community
- Sept. 2022 – Present** **We Climb (fake) Rocks - Recreational Climbing Club**
Cambridge, ON
Organizer
- Sept. 2021 – Present** **Waterloo Architecture Christian Fellowship**
Cambridge, ON
Coordinator
- Sept. 2021 – Dec. 2021** **Waterloo Architecture Students Association**
Cambridge, ON
President
 - Coordinate and delegate roles within the Undergraduate Student Council.
 - Represent the student body to Cambridge community, faculty, and staff.
- May 2019 – Aug. 2019** **Iconography Play: Leviathan**
Cambridge, ON
Producer
 - In ARCH 248 curriculum, I coordinated all 15 production teams, ensured completion on time, delegated tasks, resolved conflicts, and overall, kept spirits up.
- Jan. 2018 – Present** **BRIDGE Centre for Architecture + Design**
Cambridge, ON
Social Media Coordinator + Published Author
 - Plan, post, and monitor BRIDGE's Instagram.
 - Publish articles and photograph events.
- Nov. 2018 – Sept. 2019** **University Of Waterloo: Waterloo Orientation Team**
Cambridge, ON
Architecture Orientation Coordinator
 - Accountable for executing Architecture Orientation 2019, through budgeting, hiring leaders, monitoring, and surveying.
 - Successfully make our students feel a part of the faculty of Engineering despite being a satellite campus from the University of Waterloo.
- Sept. 2018 – Aug. 2019** **Waterloo Architecture Students Association**
Cambridge, ON
Class Representative
 - Facilitate communication between class and faculty.
 - Voice class' concerns, suggestions, and questions.

Achievements

- Aug. 2022** **Honors with Distinction** graduation at University of Waterloo
- Sept. 2021** **Recipient of the Jim Kalbfleisch Award**
- Aug. 2020** **First Place** in BREWED Competition hosted by uni.xyz
- Feb. 2020** **Finalist** in Expand Your Empire Case Competition
- May 2019** **Best Original Design** in Construction Toronto
- July 2018** **Employee of the Month** at Journeys
- Sept. 2017 - Aug. 2022** **Excellent Academic Standing** at University of Waterloo





✉ dvrgrabe@uwaterloo.ca
☎ 647-515-7706

Hello! I'm Dani,

Work Experience

Jan. 2022 – Apr. 2022
Vancouver, BC

MGBA
Architectural Intern

- Developed Rezoning and Development Permit drawing packages for a new condo, including calculating FSR, iterating massing models, and drawing unit plans.
- Created Revit models from scratch

Jan. 2021 – Aug. 2021
Montréal, QC

Architecture49
Étudiante en Architecture

- Worked fluently in French.
- Solely responsible for modeling a major industrial building in Revit.
- BIM (Building Information Modeling) and data manager for cost estimating.
- Collaborated with architects and six teams of engineering consultants.

Sept. 2019 – Dec. 2019
New York, NY

HLW
Interior Design Intern

- Worked on SD, DD, and CA phases on office renovation projects.
- Built Revit models from CAD drawings, drew construction details, and made Enscape renders
- Compiled furniture bid packages and finish sample boards for clients.

Jan. 2019 – Apr. 2019
Toronto, ON

Architecture 49
Architectural Assistant

- Rendered images in Vray for transportation projects.
- Developed an Accessibility for Ontarians with Disabilities Act (AODA) Compliance Checklist.
- Held meetings with product and material representatives.

Relevant Skills

| Software | Fabrication | Languages |
|----------------------------|---------------------|--------------------|
| — Revit | — Physical Modeling | — English (fluent) |
| — Enscape | — Hand Drafting | — French (working) |
| — Rhinoceros | — Laser Cutting | |
| — Vray | — CNC Milling | |
| — AutoCAD | — 3D Printing | |
| — SketchUp | — Woodworking | |
| — Adobe Ps, Ai, Id, Lr, Pr | | |

Education

Sept. 2022 – Present
Cambridge, ON

University of Waterloo
Master of Architecture

Sept. 2017 – Aug. 2022
Cambridge, ON

University of Waterloo
Bachelor of Architectural Studies Honors Co-Op

Leadership Involvement

Sept. 2022 – Present
Cambridge, ON

BRIDGE Centre for Architecture + Design
Director

- Coordinate, structure, organize, and run the student-run initiative striving to bridge the gap between the School of Architecture and the community of Cambridge, ON.

Sept. 2022 – Present
Cambridge, ON

Mentorship for Architecture Peers
Mentor

- Discuss academic and professional matters, recommend and refer them to campus resources, and promote healthy mentalities toward school.
- Mentoring 1 group of first-year undergraduate and 1 group of first-year graduate students to aid their transition into the Waterloo Architecture community

Sept. 2022 – Present
Cambridge, ON

We Climb (fake) Rocks - Recreational Climbing Club
Organizer

Sept. 2021 – Present
Cambridge, ON

Waterloo Architecture Christian Fellowship
Coordinator

Sept. 2021 – Dec. 2021
Jan. 2020 – Apr. 2020

Waterloo Architecture Students Association
President

- Coordinate and delegate roles within the Undergraduate Student Council.
- Represent the student body to Cambridge community, faculty, and staff.

May 2019 – Aug. 2019
Cambridge, ON

Iconography Play: Leviathan
Producer

- In ARCH 248 curriculum, I coordinated all 15 production teams, ensured completion on time, delegated tasks, resolved conflicts, and overall, kept spirits up.

Jan. 2018 – Present
Cambridge, ON

BRIDGE Centre for Architecture + Design
Social Media Coordinator + Published Author

- Plan, post, and monitor BRIDGE's Instagram.
- Publish articles and photograph events.

Nov. 2018 – Sept. 2019
Cambridge, ON

University Of Waterloo: Waterloo Orientation Team
Architecture Orientation Coordinator

- Accountable for executing Architecture Orientation 2019, through budgeting, hiring leaders, monitoring, and surveying.
- Successfully make our students feel a part of the faculty of Engineering despite being a satellite campus from the University of Waterloo.

Sept. 2018 – Aug. 2019
Cambridge, ON

Waterloo Architecture Students Association
Class Representative

- Facilitate communication between class and faculty.
- Voice class' concerns, suggestions, and questions.

Achievements

Aug. 2022

Honors with Distinction graduation at University of Waterloo

Sept. 2021

Recipient of the Jim Kalbfleisch Award

Aug. 2020

First Place in BREWED Competition hosted by uni.xyz

Feb. 2020

Finalist in Expand Your Empire Case Competition

May 2019

Best Original Design in Construction Toronto

July 2018

Employee of the Month at Journeys

Sept. 2017 - Aug. 2022

Excellent Academic Standing at University of Waterloo

WHAT IS A CV?

- Different from a resume!
- Full list of your work experience, skills, community involvement, education, and achievements
- Typically included in your portfolio
- The first thing an employer will look at is your resume to access your capabilities, THEN they move to your portfolio with your CV included
- Not necessarily two pages, I just have a lot of experience by this point in my life <3





dvgrabke@uwaterloo.ca
647-515-7706

Hello! I'm Dani,

Work Experience

Jan. 2022 – Apr. 2022
Vancouver, BC

MGBA
Architectural Intern

- Developed Rezoning and Development Permit drawing packages for a new condo, including calculating FSR, iterating massing models, and drawing unit plans.
- Created Revit models from scratch

Jan. 2021 – Aug. 2021
Montréal, QC

Architecture49
Étudiante en Architecture

- Worked fluently in French.
- Solely responsible for modeling a major industrial building in Revit.
- BIM (Building Information Modeling) and data manager for cost estimating.
- Collaborated with architects and six teams of engineering consultants.

Sept. 2019 – Dec. 2019
New York, NY

HLW
Interior Design Intern

- Worked on SD, DD, and CA phases on office renovation projects.
- Built Revit models from CAD drawings, drew construction details, and made Enscape renders
- Compiled furniture bid packages and finish sample boards for clients.

Jan. 2019 – Apr. 2019
Toronto, ON

Architecture 49
Architectural Assistant

- Rendered images in Vray for transportation projects.
- Developed an Accessibility for Ontarians with Disabilities Act (AODA) Compliance Checklist.
- Held meetings with product and material representatives.

Relevant Skills

| Software | Fabrication | Languages |
|----------------------------|-------------------|------------------|
| — Revit | Physical Modeling | English (fluent) |
| — Enscape | Hand Drafting | French (working) |
| — Rhinoceros | Laser Cutting | |
| — Vray | CNC Milling | |
| — AutoCAD | 3D Printing | |
| — SketchUp | Woodworking | |
| — Adobe Ps, Ai, Id, Lr, Pr | | |

Education

Sept. 2022 – Present
Cambridge, ON

University of Waterloo
Master of Architecture

Sept. 2017 – Aug. 2022
Cambridge, ON

University of Waterloo
Bachelor of Architectural Studies Honors Co-Op

Leadership Involvement

Sept. 2022 – Present
Cambridge, ON

BRIDGE Centre for Architecture + Design
Director

- Coordinate, structure, organize, and run the student-run initiative striving to bridge the gap between the School of Architecture and the community of Cambridge, ON.

Sept. 2022 – Present
Cambridge, ON

Mentorship for Architecture Peers
Mentor

- Discuss academic and professional matters, recommend and refer them to campus resources, and promote healthy mentalities toward school.
- Mentoring 1 group of first-year undergraduate and 1 group of first-year graduate students to aid their transition into the Waterloo Architecture community

Sept. 2022 – Present
Cambridge, ON

We Climb (fake) Rocks - Recreational Climbing Club
Organizer

Sept. 2021 – Present
Cambridge, ON

Waterloo Architecture Christian Fellowship
Coordinator

Sept. 2021 – Dec. 2021
Jan. 2020 – Apr. 2020

Waterloo Architecture Students Association
President

- Coordinate and delegate roles within the Undergraduate Student Council. Represent the student body to Cambridge community, faculty, and staff.

May 2019 – Aug. 2019
Cambridge, ON

Iconography Play: Leviathan
Producer

- In ARCH 248 curriculum, I coordinated all 15 production teams, ensured completion on time, delegated tasks, resolved conflicts, and overall, kept spirits up.

Jan. 2018 – Present
Cambridge, ON

BRIDGE Centre for Architecture + Design
Social Media Coordinator + Published Author

- Plan, post, and monitor BRIDGE's Instagram.
- Publish articles and photograph events.

Nov. 2018 – Sept. 2019
Cambridge, ON

University Of Waterloo: Waterloo Orientation Team
Architecture Orientation Coordinator

- Accountable for executing Architecture Orientation 2019, through budgeting, hiring leaders, monitoring, and surveying.
- Successfully make our students feel a part of the faculty of Engineering despite being a satellite campus from the University of Waterloo.

Sept. 2018 – Aug. 2019
Cambridge, ON

Waterloo Architecture Students Association
Class Representative

- Facilitate communication between class and faculty.
- Voice class' concerns, suggestions, and questions.

Achievements

Aug. 2022

Honors with Distinction graduation at University of Waterloo

Sept. 2021

Recipient of the Jim Kalbfleisch Award

Aug. 2020

First Place in BREWED Competition hosted by uni.xyz

Feb. 2020

Finalist in Expand Your Empire Case Competition

May 2019

Best Original Design in Construction Toronto

July 2018

Employee of the Month at Journeys

Sept. 2017 - Aug. 2022

Excellent Academic Standing at University of Waterloo

A GOOD CV:

- Clear layout
 - Text hierarchy
 - Visual Breaks
 - Succinct descriptions
 - Consistent margins and spaces
- Relevant Content
- ! Should be able to find what you're looking for in a matter of seconds





dvgrabke@uwaterloo.ca
647-515-7706

Hello! I'm Dani,

Work Experience

- Jan. 2022 – Apr. 2022** **MGBA**
Vancouver, BC
Architectural Intern
 - Developed Rezoning and Development Permit drawing packages for a new condo, including calculating FSR, iterating massing models, and drawing unit plans.
 - Created Revit models from scratch
- Jan. 2021 – Aug. 2021** **Architecture49**
Montréal, QC
Étudiante en Architecture
 - Worked fluently in French.
 - Solely responsible for modeling a major industrial building in Revit.
 - BIM (Building Information Modeling) and data manager for cost estimating.
 - Collaborated with architects and six teams of engineering consultants.
- Sept. 2019 – Dec. 2019** **HLW**
New York, NY
Interior Design Intern
 - Worked on SD, DD, and CA phases on office renovation projects.
 - Built Revit models from CAD drawings, drew construction details, and made Enscape renders
 - Compiled furniture bid packages and finish sample boards for clients.
- Jan. 2019 – Apr. 2019** **Architecture 49**
Toronto, ON
Architectural Assistant
 - Rendered images in Vray for transportation projects.
 - Developed an Accessibility for Ontarians with Disabilities Act (AODA) Compliance Checklist.
 - Held meetings with product and material representatives.

Relevant Skills

| Software | Fabrication | Languages |
|--------------------------|-------------------|------------------|
| Revit | Physical Modeling | English (fluent) |
| Enscape | Hand Drafting | French (working) |
| Rhinoceros | Laser Cutting | |
| Vray | CNC Milling | |
| AutoCAD | 3D Printing | |
| SketchUp | Woodworking | |
| Adobe Ps, Ai, Id, Lr, Pr | | |

Education

- Sept. 2022 – Present** **University of Waterloo**
Cambridge, ON
Master of Architecture
- Sept. 2017 – Aug. 2022** **University of Waterloo**
Cambridge, ON
Bachelor of Architectural Studies Honors Co-Op

Leadership Involvement

- Sept. 2022 – Present** **BRIDGE Centre for Architecture + Design**
Cambridge, ON
Director
 - Coordinate, structure, organize, and run the student-run initiative striving to bridge the gap between the School of Architecture and the community of Cambridge, ON.
- Sept. 2022 – Present** **Mentorship for Architecture Peers**
Cambridge, ON
Mentor
 - Discuss academic and professional matters, recommend and refer them to campus resources, and promote healthy mentalities toward school.
 - Mentoring 1 group of first-year undergraduate and 1 group of first-year graduate students to aid their transition into the Waterloo Architecture community
- Sept. 2022 – Present** **We Climb (fake) Rocks - Recreational Climbing Club**
Cambridge, ON
Organizer
- Sept. 2021 – Present** **Waterloo Architecture Christian Fellowship**
Cambridge, ON
Coordinator
- Sept. 2021 – Dec. 2021** **Waterloo Architecture Students Association**
Jan. 2020 – Apr. 2020
Cambridge, ON
President
 - Coordinate and delegate roles within the Undergraduate Student Council.
 - Represent the student body to Cambridge community, faculty, and staff.
- May 2019 – Aug. 2019** **Iconography Play: Leviathan**
Cambridge, ON
Producer
 - In ARCH 248 curriculum, I coordinated all 15 production teams, ensured completion on time, delegated tasks, resolved conflicts, and overall, kept spirits up.
- Jan. 2018 – Present** **BRIDGE Centre for Architecture + Design**
Cambridge, ON
Social Media Coordinator + Published Author
 - Plan, post, and monitor BRIDGE's Instagram.
 - Publish articles and photograph events.
- Nov. 2018 – Sept. 2019** **University Of Waterloo: Waterloo Orientation Team**
Cambridge, ON
Architecture Orientation Coordinator
 - Accountable for executing Architecture Orientation 2019, through budgeting, hiring leaders, monitoring, and surveying.
 - Successfully make our students feel a part of the faculty of Engineering despite being a satellite campus from the University of Waterloo.
- Sept. 2018 – Aug. 2019** **Waterloo Architecture Students Association**
Cambridge, ON
Class Representative
 - Facilitate communication between class and faculty.
 - Voice class' concerns, suggestions, and questions.

Achievements

- Aug. 2022** **Honors with Distinction** graduation at University of Waterloo
- Sept. 2021** **Recipient of the Jim Kalbfleisch Award**
- Aug. 2020** **First Place** in BREWED Competition hosted by uni.xyz
- Feb. 2020** **Finalist** in Expand Your Empire Case Competition
- May 2019** **Best Original Design** in Construction Toronto
- July 2018** **Employee of the Month** at Journeys
- Sept. 2017 - Aug. 2022** **Excellent Academic Standing** at University of Waterloo

A GOOD CV:

- Clear layout
 - Text hierarchy
 - Visual Breaks
 - Succinct descriptions
 - Consistent margins and spaces
- Relevant Content
- ! Should be able to find what you're looking for in a matter of seconds
 - Headings





✉ dvrabke@uwaterloo.ca
☎ 647-515-7706

Hello! I'm Dani,

Work Experience

Jan. 2022 – Apr. 2022
Vancouver, BC

MGBA
Architectural Intern

- Developed Rezoning and Development Permit drawing packages for a new condo, including calculating FSR, iterating massing models, and drawing unit plans.
- Created Revit models from scratch

Jan. 2021 – Aug. 2021
Montréal, QC

Architecture49
Étudiante en Architecture

- Worked fluently in French.
- Solely responsible for modeling a major industrial building in Revit.
- BIM (Building Information Modeling) and data manager for cost estimating.
- Collaborated with architects and six teams of engineering consultants.

Sept. 2019 – Dec. 2019
New York, NY

HLW
Interior Design Intern

- Worked on SD, DD, and CA phases on office renovation projects.
- Built Revit models from CAD drawings, drew construction details, and made Enscape renders
- Compiled furniture bid packages and finish sample boards for clients.

Jan. 2019 – Apr. 2019
Toronto, ON

Architecture 49
Architectural Assistant

- Rendered images in Vray for transportation projects.
- Developed an Accessibility for Ontarians with Disabilities Act (AODA) Compliance Checklist.
- Held meetings with product and material representatives.

Relevant Skills

Software

- Revit
- Enscape
- Rhinoceros
- Vray
- AutoCAD
- SketchUp
- Adobe Ps, Ai, Id, Lr, Pr

Fabrication

- Physical Modeling
- Hand Drafting
- Laser Cutting
- CNC Milling
- 3D Printing
- Woodworking

Languages

- English (fluent)
- French (working)

Education

Sept. 2022 – Present
Cambridge, ON

University of Waterloo
Master of Architecture

Sept. 2017 – Aug. 2022
Cambridge, ON

University of Waterloo
Bachelor of Architectural Studies Honors Co-Op

Leadership Involvement

Sept. 2022 – Present
Cambridge, ON

BRIDGE Centre for Architecture + Design
Director

- Coordinate, structure, organize, and run the student-run initiative striving to bridge the gap between the School of Architecture and the community of Cambridge, ON.

Sept. 2022 – Present
Cambridge, ON

Mentorship for Architecture Peers
Mentor

- Discuss academic and professional matters, recommend and refer them to campus resources, and promote healthy mentalities toward school.
- Mentoring 1 group of first-year undergraduate and 1 group of first-year graduate students to aid their transition into the Waterloo Architecture community

Sept. 2022 – Present
Cambridge, ON

We Climb (fake) Rocks - Recreational Climbing Club
Organizer

Sept. 2021 – Present
Cambridge, ON

Waterloo Architecture Christian Fellowship
Coordinator

Sept. 2021 – Dec. 2021
Jan. 2020 – Apr. 2020
Cambridge, ON

Waterloo Architecture Students Association
President

- Coordinate and delegate roles within the Undergraduate Student Council.
- Represent the student body to Cambridge community, faculty, and staff.

May 2019 – Aug. 2019
Cambridge, ON

Iconography Play: Leviathan
Producer

- In ARCH 248 curriculum, I coordinated all 15 production teams, ensured completion on time, delegated tasks, resolved conflicts, and overall, kept spirits up.

Jan. 2018 – Present
Cambridge, ON

BRIDGE Centre for Architecture + Design
Social Media Coordinator + Published Author

- Plan, post, and monitor BRIDGE's Instagram.
- Publish articles and photograph events.

Nov. 2018 – Sept. 2019
Cambridge, ON

University Of Waterloo: Waterloo Orientation Team
Architecture Orientation Coordinator

- Accountable for executing Architecture Orientation 2019, through budgeting, hiring leaders, monitoring, and surveying.
- Successfully make our students feel a part of the faculty of Engineering despite being a satellite campus from the University of Waterloo.

Sept. 2018 – Aug. 2019
Cambridge, ON

Waterloo Architecture Students Association
Class Representative

- Facilitate communication between class and faculty.
- Voice class' concerns, suggestions, and questions.

Achievements

Aug. 2022

Honors with Distinction graduation at University of Waterloo

Sept. 2021

Recipient of the Jim Kalbfleisch Award

Aug. 2020

First Place in BREWED Competition hosted by uni.xyz

Feb. 2020

Finalist in Expand Your Empire Case Competition

May 2019

Best Original Design in Construction Toronto

July 2018

Employee of the Month at Journeys

Sept. 2017 - Aug. 2022

Excellent Academic Standing at University of Waterloo

A GOOD CV:

- Clear layout
 - Text hierarchy
 - Visual Breaks
 - Succinct descriptions
 - Consistent margins and spaces
- Relevant Content
- ! Should be able to find what you're looking for in a matter of seconds
 - Headings
 - Dates





dygrabke@uwaterloo.ca
647-515-7706

Hello! I'm Dani,

Work Experience

Jan. 2022 – Apr. 2022
Vancouver, BC **MGBA**
Architectural Intern

- Developed Rezoning and Development Permit drawing packages for a new condo, including calculating FSR, iterating massing models, and drawing unit plans.
- Created Revit models from scratch

Jan. 2021 – Aug. 2021
Montréal, QC **Architecture49**
Étudiante en Architecture

- Worked fluently in French.
- Solely responsible for modeling a major industrial building in Revit.
- BIM (Building Information Modeling) and data manager for cost estimating.
- Collaborated with architects and six teams of engineering consultants.

Sept. 2019 – Dec. 2019
New York, NY **HILW**
Interior Design Intern

- Worked on SD, DD, and CA phases on office renovation projects.
- Built Revit models from CAD drawings, drew construction details, and made Enscape renders
- Compiled furniture bid packages and finish sample boards for clients.

Jan. 2019 – Apr. 2019
Toronto, ON **Architecture 49**
Architectural Assistant

- Rendered images in Vray for transportation projects.
- Developed an Accessibility for Ontarians with Disabilities Act (AODA) Compliance Checklist.
- Held meetings with product and material representatives.

Relevant Skills

| Software | Fabrication | Languages |
|--------------------------|-------------------|------------------|
| Revit | Physical Modeling | English (fluent) |
| Enscape | Hand Drafting | French (working) |
| Rhinoceros | Laser Cutting | |
| Vray | CNC Milling | |
| AutoCAD | 3D Printing | |
| SketchUp | Woodworking | |
| Adobe Ps, Ai, Id, Lr, Pr | | |

Education

Sept. 2022 – Present
Cambridge, ON **University of Waterloo**
Master of Architecture

Sept. 2017 – Aug. 2022
Cambridge, ON **University of Waterloo**
Bachelor of Architectural Studies Honors Co-Op

Leadership Involvement

Sept. 2022 – Present
Cambridge, ON **BRIDGE Centre for Architecture + Design**
Director

- Coordinate, structure, organize, and run the student-run initiative striving to bridge the gap between the School of Architecture and the community of Cambridge, ON.

Sept. 2022 – Present
Cambridge, ON **Mentorship for Architecture Peers**
Mentor

- Discuss academic and professional matters, recommend and refer them to campus resources, and promote healthy mentalities toward school.
- Mentoring 1 group of first-year undergraduate and 1 group of first-year graduate students to aid their transition into the Waterloo Architecture community

Sept. 2022 – Present
Cambridge, ON **We Climb (fake) Rocks - Recreational Climbing Club**
Organizer

Sept. 2021 – Present
Cambridge, ON **Waterloo Architecture Christian Fellowship**
Coordinator

Sept. 2021 – Dec. 2022
Jan. 2020 – Apr. 2022
Cambridge, ON **Waterloo Architecture Students Association**
President

- Coordinate and delegate roles within the Undergraduate Student Council.
- Represent the student body to Cambridge community, faculty, and staff.

May 2019 – Aug. 2019
Cambridge, ON **Iconography Play: Leviathan**
Producer

- In ARCH 248 curriculum, I coordinated all 15 production teams, ensured completion on time, delegated tasks, resolved conflicts, and overall, kept spirits up.

Jan. 2018 – Present
Cambridge, ON **BRIDGE Centre for Architecture + Design**
Social Media Coordinator + Published Author

- Plan, post, and monitor BRIDGE's Instagram.
- Publish articles and photograph events.

Nov. 2018 – Sept. 2019
Cambridge, ON **University Of Waterloo: Waterloo Orientation Team**
Architecture Orientation Coordinator

- Accountable for executing Architecture Orientation 2019, through budgeting, hiring leaders, monitoring, and surveying.
- Successfully make our students feel a part of the faculty of Engineering despite being a satellite campus from the University of Waterloo.

Sept. 2018 – Aug. 2019
Cambridge, ON **Waterloo Architecture Students Association**
Class Representative

- Facilitate communication between class and faculty.
- Voice class' concerns, suggestions, and questions.

Achievements

Aug. 2022 **Honors with Distinction** graduation at University of Waterloo

Sept. 2021 **Recipient of the Jim Kalbfleisch Award**

Aug. 2020 **First Place** in BREWED Competition hosted by uni.xyz

Feb. 2020 **Finalist** in Expand Your Empire Case Competition

May 2019 **Best Original Design** in Construction Toronto

July 2018 **Employee of the Month** at Journeys

Sept. 2017 - Aug. 2022 **Excellent Academic Standing** at University of Waterloo

A GOOD CV:

- Clear layout
 - Text hierarchy
 - Visual Breaks
 - Succinct descriptions
 - Consistent margins and spaces
- Relevant Content
- ! Should be able to find what you're looking for in a matter of seconds
 - Headings
 - Dates
 - Firm / Position Title





dvgrabke@uwaterloo.ca
647-515-7706

Hello! I'm Dani,

Work Experience

Jan. 2022 – Apr. 2022
Vancouver, BC

MGBA
Architectural Intern

- Developed Rezoning and Development Permit drawing packages for a new condo, including calculating FSR, iterating massing models, and drawing unit plans.
- Created Revit models from scratch

Jan. 2021 – Aug. 2021
Montréal, QC

Architecture49
Étudiante en Architecture

- Worked fluently in French.
- Solely responsible for modeling a major industrial building in Revit.
- BIM (Building Information Modeling) and data manager for cost estimating.
- Collaborated with architects and six teams of engineering consultants.

Sept. 2019 – Dec. 2019
New York, NY

HLW
Interior Design Intern

- Worked on SD, DD, and CA phases on office renovation projects.
- Built Revit models from CAD drawings, drew construction details, and made Enscape renders
- Compiled furniture bid packages and finish sample boards for clients.

Jan. 2019 – Apr. 2019
Toronto, ON

Architecture 49
Architectural Assistant

- Rendered images in Vray for transportation projects.
- Developed an Accessibility for Ontarians with Disabilities Act (AODA) Compliance Checklist.
- Held meetings with product and material representatives.

Relevant Skills

| Software | Fabrication | Languages |
|--------------------------|-------------------|------------------|
| Revit | Physical Modeling | English (fluent) |
| Enscape | Hand Drafting | French (working) |
| Rhinoceros | Laser Cutting | |
| Vray | CNC Milling | |
| AutoCAD | 3D Printing | |
| SketchUp | Woodworking | |
| Adobe Ps, Ai, Id, Lr, Pr | | |

Education

Sept. 2022 – Present
Cambridge, ON

University of Waterloo
Master of Architecture

Sept. 2017 – Aug. 2022
Cambridge, ON

University of Waterloo
Bachelor of Architectural Studies Honors Co-Op

Leadership Involvement

Sept. 2022 – Present
Cambridge, ON

BRIDGE Centre for Architecture + Design
Director

- Coordinate, structure, organize, and run the student-run initiative striving to bridge the gap between the School of Architecture and the community of Cambridge, ON.

Sept. 2022 – Present
Cambridge, ON

Mentorship for Architecture Peers
Mentor

- Discuss academic and professional matters, recommend and refer them to campus resources, and promote healthy mentalities toward school.
- Mentoring 1 group of first-year undergraduate and 1 group of first-year graduate students to aid their transition into the Waterloo Architecture community.

Sept. 2022 – Present
Cambridge, ON

We Climb (fake) Rocks - Recreational Climbing Club
Organizer

Sept. 2021 – Present
Cambridge, ON

Waterloo Architecture Christian Fellowship
Coordinator

Sept. 2021 – Dec. 2021
Jan. 2020 – Apr. 2020

Waterloo Architecture Students Association
President

- Coordinate and delegate roles within the Undergraduate Student Council.
- Represent the student body to Cambridge community, faculty, and staff.

May 2019 – Aug. 2019
Cambridge, ON

Iconography Play: Leviathan
Producer

- In ARCH 248 curriculum, I coordinated all 15 production teams, ensured completion on time, delegated tasks, resolved conflicts, and overall, kept spirits up.

Jan. 2018 – Present
Cambridge, ON

BRIDGE Centre for Architecture + Design
Social Media Coordinator + Published Author

- Plan, post, and monitor BRIDGE's Instagram.
- Publish articles and photograph events.

Nov. 2018 – Sept. 2019
Cambridge, ON

University Of Waterloo: Waterloo Orientation Team
Architecture Orientation Coordinator

- Accountable for executing Architecture Orientation 2019, through budgeting, hiring leaders, monitoring, and surveying.
- Successfully make our students feel a part of the faculty of Engineering despite being a satellite campus from the University of Waterloo.

Sept. 2018 – Aug. 2019
Cambridge, ON

Waterloo Architecture Students Association
Class Representative

- Facilitate communication between class and faculty.
- Voice class' concerns, suggestions, and questions.

Achievements

Aug. 2022

Honors with Distinction graduation at University of Waterloo

Sept. 2021

Recipient of the Jim Kalbfleisch Award

Aug. 2020

First Place in BREWED Competition hosted by uni.xyz

Feb. 2020

Finalist in Expand Your Empire Case Competition

May 2019

Best Original Design in Construction Toronto

July 2018

Employee of the Month at Journeys

Sept. 2017 - Aug. 2022

Excellent Academic Standing at University of Waterloo

A GOOD CV:

- Clear layout
 - Text hierarchy
 - Visual Breaks
 - Succinct descriptions
 - Consistent margins and spaces
- Relevant Content
- ! Should be able to find what you're looking for in a matter of seconds
 - Headings
 - Dates
 - Firm / Position Title
 - Descriptions





✉ dgrabke@uwaterloo.ca
☎ 647-515-7706

Hello! I'm Dani,

Work Experience

- Jan. 2022 – Apr. 2022** **MGBA**
Vancouver, BC
Architectural Intern
 - Developed Rezoning and Development Permit drawing packages for a new condo, including calculating FSR, iterating massing models, and drawing unit plans.
 - Created Revit models from scratch
- Jan. 2021 – Aug. 2021** **Architecture49**
Montréal, QC
Étudiante en Architecture
 - Worked fluently in French.
 - Solely responsible for modeling a major industrial building in Revit.
 - BIM (Building Information Modeling) and data manager for cost estimating.
 - Collaborated with architects and six teams of engineering consultants.
- Sept. 2019 – Dec. 2019** **HLW**
New York, NY
Interior Design Intern
 - Worked on SD, DD, and CA phases on office renovation projects.
 - Built Revit models from CAD drawings, drew construction details, and made Enscape renders
 - Compiled furniture bid packages and finish sample boards for clients.
- Jan. 2019 – Apr. 2019** **Architecture 49**
Toronto, ON
Architectural Assistant
 - Rendered images in Vray for transportation projects.
 - Developed an Accessibility for Ontarians with Disabilities Act (AODA) Compliance Checklist.
 - Held meetings with product and material representatives.

Relevant Skills

| Software | Fabrication | Languages |
|----------------------------|-------------------|------------------|
| — Revit | Physical Modeling | English (fluent) |
| — Enscape | Hand Drafting | French (working) |
| — Rhinoceros | Laser Cutting | |
| — Vray | CNC Milling | |
| — AutoCAD | 3D Printing | |
| — SketchUp | Woodworking | |
| — Adobe Ps, Ai, Id, Lr, Pr | | |

Education

- Sept. 2022 – Present** **University of Waterloo**
Cambridge, ON
Master of Architecture
- Sept. 2017 – Aug. 2022** **University of Waterloo**
Cambridge, ON
Bachelor of Architectural Studies Honors Co-Op

Leadership Involvement

- Sept. 2022 – Present** **BRIDGE Centre for Architecture + Design**
Cambridge, ON
Director
 - Coordinate, structure, organize, and run the student-run initiative striving to bridge the gap between the School of Architecture and the community of Cambridge, ON.
- Sept. 2022 – Present** **Mentorship for Architecture Peers**
Cambridge, ON
Mentor
 - Discuss academic and professional matters, recommend and refer them to campus resources, and promote healthy mentalities toward school.
 - Mentoring 1 group of first-year undergraduate and 1 group of first-year graduate students to aid their transition into the Waterloo Architecture community
- Sept. 2022 – Present** **We Climb (fake) Rocks - Recreational Climbing Club**
Cambridge, ON
Organizer
- Sept. 2021 – Present** **Waterloo Architecture Christian Fellowship**
Cambridge, ON
Coordinator
- Sept. 2021 – Dec. 2021** **Waterloo Architecture Students Association**
Cambridge, ON
President
 - Coordinate and delegate roles within the Undergraduate Student Council.
 - Represent the student body to Cambridge community, faculty, and staff.
- Jan. 2020 – Apr. 2020** **Waterloo Architecture Students Association**
Cambridge, ON
President
 - Coordinate and delegate roles within the Undergraduate Student Council.
 - Represent the student body to Cambridge community, faculty, and staff.
- May 2019 – Aug. 2019** **Iconography Play: Leviathan**
Cambridge, ON
Producer
 - In ARCH 248 curriculum, I coordinated all 15 production teams, ensured completion on time, delegated tasks, resolved conflicts, and overall, kept spirits up.
- Jan. 2018 – Present** **BRIDGE Centre for Architecture + Design**
Cambridge, ON
Social Media Coordinator + Published Author
 - Plan, post, and monitor BRIDGE's Instagram.
 - Publish articles and photograph events.
- Nov. 2018 – Sept. 2019** **University Of Waterloo: Waterloo Orientation Team**
Cambridge, ON
Architecture Orientation Coordinator
 - Accountable for executing Architecture Orientation 2019, through budgeting, hiring leaders, monitoring, and surveying.
 - Successfully make our students feel a part of the faculty of Engineering despite being a satellite campus from the University of Waterloo.
- Sept. 2018 – Aug. 2019** **Waterloo Architecture Students Association**
Cambridge, ON
Class Representative
 - Facilitate communication between class and faculty.
 - Voice class' concerns, suggestions, and questions.

Achievements

- Aug. 2022** **Honors with Distinction** graduation at University of Waterloo
- Sept. 2021** **Recipient of the Jim Kalbfleisch Award**
- Aug. 2020** **First Place** in BREWED Competition hosted by uni.xyz
- Feb. 2020** **Finalist** in Expand Your Empire Case Competition
- May 2019** **Best Original Design** in Construction Toronto
- July 2018** **Employee of the Month** at Journeys
- Sept. 2017 - Aug. 2022** **Excellent Academic Standing** at University of Waterloo

- Contact Information!
 - Make this as clear as possible
 - First thing on the page





dvgrabke@uwaterloo.ca
647-515-7706

Hello! I'm Dani,

Work Experience

Jan. 2022 – Apr. 2022
Vancouver, BC

MGBA
Architectural Intern

- Developed Rezoning and Development Permit drawing packages for a new condo, including calculating FSR, iterating massing models, and drawing unit plans.
- Created Revit models from scratch

Jan. 2021 – Aug. 2021
Montréal, QC

Architecture49
Étudiante en Architecture

- Worked fluently in French.
- Solely responsible for modeling a major industrial building in Revit.
- BIM (Building Information Modeling) and data manager for cost estimating.
- Collaborated with architects and six teams of engineering consultants.

Sept. 2019 – Dec. 2019
New York, NY

HLW
Interior Design Intern

- Worked on SD, DD, and CA phases on office renovation projects.
- Built Revit models from CAD drawings, drew construction details, and made Enscape renders
- Compiled furniture bid packages and finish sample boards for clients.

Jan. 2019 – Apr. 2019
Toronto, ON

Architecture 49
Architectural Assistant

- Rendered images in Vray for transportation projects.
- Developed an Accessibility for Ontarians with Disabilities Act (AODA) Compliance Checklist.
- Held meetings with product and material representatives.

Relevant Skills

| Software | Fabrication | Languages |
|----------------------------|-------------------|------------------|
| — Revit | Physical Modeling | English (fluent) |
| — Enscape | Hand Drafting | French (working) |
| — Rhinoceros | Laser Cutting | |
| — Vray | CNC Milling | |
| — AutoCAD | 3D Printing | |
| — SketchUp | Woodworking | |
| — Adobe Ps, Ai, Id, Lr, Pr | | |

Education

Sept. 2022 – Present
Cambridge, ON

University of Waterloo
Master of Architecture

Sept. 2017 – Aug. 2022
Cambridge, ON

University of Waterloo
Bachelor of Architectural Studies Honors Co-Op

Leadership Involvement

Sept. 2022 – Present
Cambridge, ON

BRIDGE Centre for Architecture + Design
Director

- Coordinate, structure, organize, and run the student-run initiative striving to bridge the gap between the School of Architecture and the community of Cambridge, ON.

Sept. 2022 – Present
Cambridge, ON

Mentorship for Architecture Peers
Mentor

- Discuss academic and professional matters, recommend and refer them to campus resources, and promote healthy mentalities toward school.
- Mentoring 1 group of first-year undergraduate and 1 group of first-year graduate students to aid their transition into the Waterloo Architecture community

Sept. 2022 – Present
Cambridge, ON

We Climb (fake) Rocks - Recreational Climbing Club
Organizer

Sept. 2021 – Present
Cambridge, ON

Waterloo Architecture Christian Fellowship
Coordinator

Sept. 2021 – Dec. 2021
Jan. 2020 – Apr. 2020

Waterloo Architecture Students Association
President

- Coordinate and delegate roles within the Undergraduate Student Council.
- Represent the student body to Cambridge community, faculty, and staff.

May 2019 – Aug. 2019
Cambridge, ON

Iconography Play: Leviathan
Producer

- In ARCH 248 curriculum, I coordinated all 15 production teams, ensured completion on time, delegated tasks, resolved conflicts, and overall, kept spirits up.

Jan. 2018 – Present
Cambridge, ON

BRIDGE Centre for Architecture + Design
Social Media Coordinator + Published Author

- Plan, post, and monitor BRIDGE's Instagram.
- Publish articles and photograph events.

Nov. 2018 – Sept. 2019
Cambridge, ON

University Of Waterloo: Waterloo Orientation Team
Architecture Orientation Coordinator

- Accountable for executing Architecture Orientation 2019, through budgeting, hiring leaders, monitoring, and surveying.
- Successfully make our students feel a part of the faculty of Engineering despite being a satellite campus from the University of Waterloo.

Sept. 2018 – Aug. 2019
Cambridge, ON

Waterloo Architecture Students Association
Class Representative

- Facilitate communication between class and faculty.
- Voice class' concerns, suggestions, and questions.

Achievements

Aug. 2022

Honors with Distinction graduation at University of Waterloo

Sept. 2021

Recipient of the Jim Kalbfleisch Award

Aug. 2020

First Place in BREWED Competition hosted by uni.xyz

Feb. 2020

Finalist in Expand Your Empire Case Competition

May 2019

Best Original Design in Construction Toronto

July 2018

Employee of the Month at Journeys

Sept. 2017 - Aug. 2022

Excellent Academic Standing at University of Waterloo

• Name

- Preferred vs. Legal?
- Personally, preferred in portfolio, legal in resume





dvgrabke@uwaterloo.ca
647-515-7706

Hello! I'm Dani,

Work Experience

Jan. 2022 – Apr. 2022
Vancouver, BC

MGBA
Architectural Intern

- Developed Rezoning and Development Permit drawing packages for a new condo, including calculating FSR, iterating massing models, and drawing unit plans.
- Created Revit models from scratch

Jan. 2021 – Aug. 2021
Montréal, QC

Architecture49
Étudiante en Architecture

- Worked fluently in French.
- Solely responsible for modeling a major industrial building in Revit.
- BIM (Building Information Modeling) and data manager for cost estimating.
- Collaborated with architects and six teams of engineering consultants.

Sept. 2019 – Dec. 2019
New York, NY

HLW
Interior Design Intern

- Worked on SD, DD, and CA phases on office renovation projects.
- Built Revit models from CAD drawings, drew construction details, and made Enscape renders
- Compiled furniture bid packages and finish sample boards for clients.

Jan. 2019 – Apr. 2019
Toronto, ON

Architecture 49
Architectural Assistant

- Rendered images in Vray for transportation projects.
- Developed an Accessibility for Ontarians with Disabilities Act (AODA) Compliance Checklist.
- Held meetings with product and material representatives.

Relevant Skills

| Software | Fabrication | Languages |
|----------------------------|-------------------|------------------|
| — Revit | Physical Modeling | English (fluent) |
| — Enscape | Hand Drafting | French (working) |
| — Rhinoceros | Laser Cutting | |
| — Vray | CNC Milling | |
| — AutoCAD | 3D Printing | |
| — SketchUp | Woodworking | |
| — Adobe Ps, Ai, Id, Lr, Pr | | |

Education

Sept. 2022 – Present
Cambridge, ON

University of Waterloo
Master of Architecture

Sept. 2017 – Aug. 2022
Cambridge, ON

University of Waterloo
Bachelor of Architectural Studies Honors Co-Op

Leadership Involvement

Sept. 2022 – Present
Cambridge, ON

BRIDGE Centre for Architecture + Design
Director

- Coordinate, structure, organize, and run the student-run initiative striving to bridge the gap between the School of Architecture and the community of Cambridge, ON.

Sept. 2022 – Present
Cambridge, ON

Mentorship for Architecture Peers
Mentor

- Discuss academic and professional matters, recommend and refer them to campus resources, and promote healthy mentalities toward school.
- Mentoring 1 group of first-year undergraduate and 1 group of first-year graduate students to aid their transition into the Waterloo Architecture community

Sept. 2022 – Present
Cambridge, ON

We Climb (fake) Rocks - Recreational Climbing Club
Organizer

Sept. 2021 – Present
Cambridge, ON

Waterloo Architecture Christian Fellowship
Coordinator

Sept. 2021 – Dec. 2021
Jan. 2020 – Apr. 2020

Waterloo Architecture Students Association
President

- Coordinate and delegate roles within the Undergraduate Student Council.
- Represent the student body to Cambridge community, faculty, and staff.

May 2019 – Aug. 2019
Cambridge, ON

Iconography Play: Leviathan
Producer

- In ARCH 248 curriculum, I coordinated all 15 production teams, ensured completion on time, delegated tasks, resolved conflicts, and overall, kept spirits up.

Jan. 2018 – Present
Cambridge, ON

BRIDGE Centre for Architecture + Design
Social Media Coordinator + Published Author

- Plan, post, and monitor BRIDGE's Instagram.
- Publish articles and photograph events.

Nov. 2018 – Sept. 2019
Cambridge, ON

University Of Waterloo: Waterloo Orientation Team
Architecture Orientation Coordinator

- Accountable for executing Architecture Orientation 2019, through budgeting, hiring leaders, monitoring, and surveying.
- Successfully make our students feel a part of the faculty of Engineering despite being a satellite campus from the University of Waterloo.

Sept. 2018 – Aug. 2019
Cambridge, ON

Waterloo Architecture Students Association
Class Representative

- Facilitate communication between class and faculty.
- Voice class' concerns, suggestions, and questions.

Achievements

Aug. 2022

Honors with Distinction graduation at University of Waterloo

Sept. 2021

Recipient of the Jim Kalbfleisch Award

Aug. 2020

First Place in BREWED Competition hosted by uni.xyz

Feb. 2020

Finalist in Expand Your Empire Case Competition

May 2019

Best Original Design in Construction Toronto

July 2018

Employee of the Month at Journeys

Sept. 2017 - Aug. 2022

Excellent Academic Standing at University of Waterloo

Optional to include:

- **Portrait**
 - Pro: Helps put a face to your work; adds personality
 - Con: Risk of bias!
- **Personally, I use my portrait in my Portfolio and not in my resume**
 - More control over who's seeing it
 - Depending on the firm, if they ask for a resume, they might JUST go through a stack of resumes before opening portfolios





dvgrabke@uwaterloo.ca
647-515-7706

Hello! I'm Dani,

Work Experience

- Jan. 2022 – Apr. 2022** **MGBA**
Vancouver, BC
Architectural Intern
 - Developed Rezoning and Development Permit drawing packages for a new condo, including calculating FSR, iterating massing models, and drawing unit plans.
 - Created Revit models from scratch
- Jan. 2021 – Aug. 2021** **Architecture49**
Montréal, QC
Étudiante en Architecture
 - Worked fluently in French.
 - Solely responsible for modeling a major industrial building in Revit.
 - BIM (Building Information Modeling) and data manager for cost estimating.
 - Collaborated with architects and six teams of engineering consultants.
- Sept. 2019 – Dec. 2019** **HLW**
New York, NY
Interior Design Intern
 - Worked on SD, DD, and CA phases on office renovation projects.
 - Built Revit models from CAD drawings, drew construction details, and made Enscape renders
 - Compiled furniture bid packages and finish sample boards for clients.
- Jan. 2019 – Apr. 2019** **Architecture 49**
Toronto, ON
Architectural Assistant
 - Rendered images in Vray for transportation projects.
 - Developed an Accessibility for Ontarians with Disabilities Act (AODA) Compliance Checklist.
 - Held meetings with product and material representatives.

Relevant Skills

| Software | Fabrication | Languages |
|--------------------------|-------------------|------------------|
| Revit | Physical Modeling | English (fluent) |
| Enscape | Hand Drafting | French (working) |
| Rhinoceros | Laser Cutting | |
| Vray | CNC Milling | |
| AutoCAD | 3D Printing | |
| SketchUp | Woodworking | |
| Adobe Ps, Ai, Id, Lr, Pr | | |

Education

- Sept. 2022 – Present** **University of Waterloo**
Cambridge, ON
Master of Architecture
- Sept. 2017 – Aug. 2022** **University of Waterloo**
Cambridge, ON
Bachelor of Architectural Studies Honors Co-Op

Leadership Involvement

- Sept. 2022 – Present** **BRIDGE Centre for Architecture + Design**
Cambridge, ON
Director
 - Coordinate, structure, organize, and run the student-run initiative striving to bridge the gap between the School of Architecture and the community of Cambridge, ON.
- Sept. 2022 – Present** **Mentorship for Architecture Peers**
Cambridge, ON
Mentor
 - Discuss academic and professional matters, recommend and refer them to campus resources, and promote healthy mentalities toward school.
 - Mentoring 1 group of first-year undergraduate and 1 group of first-year graduate students to aid their transition into the Waterloo Architecture community
- Sept. 2022 – Present** **We Climb (fake) Rocks - Recreational Climbing Club**
Cambridge, ON
Organizer
- Sept. 2021 – Present** **Waterloo Architecture Christian Fellowship**
Cambridge, ON
Coordinator
- Sept. 2021 – Dec. 2021** **Waterloo Architecture Students Association**
Jan. 2020 – Apr. 2020
Cambridge, ON
President
 - Coordinate and delegate roles within the Undergraduate Student Council.
 - Represent the student body to Cambridge community, faculty, and staff.
- May 2019 – Aug. 2019** **Iconography Play: Leviathan**
Cambridge, ON
Producer
 - In ARCH 248 curriculum, I coordinated all 15 production teams, ensured completion on time, delegated tasks, resolved conflicts, and overall, kept spirits up.
- Jan. 2018 – Present** **BRIDGE Centre for Architecture + Design**
Cambridge, ON
Social Media Coordinator + Published Author
 - Plan, post, and monitor BRIDGE's Instagram.
 - Publish articles and photograph events.
- Nov. 2018 – Sept. 2019** **University Of Waterloo: Waterloo Orientation Team**
Cambridge, ON
Architecture Orientation Coordinator
 - Accountable for executing Architecture Orientation 2019, through budgeting, hiring leaders, monitoring, and surveying.
 - Successfully make our students feel a part of the faculty of Engineering despite being a satellite campus from the University of Waterloo.
- Sept. 2018 – Aug. 2019** **Waterloo Architecture Students Association**
Cambridge, ON
Class Representative
 - Facilitate communication between class and faculty.
 - Voice class' concerns, suggestions, and questions.

Achievements

- Aug. 2022** **Honors with Distinction** graduation at University of Waterloo
- Sept. 2021** **Recipient of the Jim Kalbfleisch Award**
- Aug. 2020** **First Place** in BREWED Competition hosted by uni.xyz
- Feb. 2020** **Finalist** in Expand Your Empire Case Competition
- May 2019** **Best Original Design** in Construction Toronto
- July 2018** **Employee of the Month** at Journeys
- Sept. 2017 - Aug. 2022** **Excellent Academic Standing** at University of Waterloo

Headings :

- Work Experience**
 - If you don't have much work or community experience, just make one heading cover both! "Experience"
- Relevant Skills**
 - Software (Rhino, Adobe)
 - Fabrication (Laser cutting, 3D printing)
 - Languages; include level of fluency!
- Education**
 - NOT AT THE TOP OF THE PAGE
- Leadership/ Community Involvement**
 - Helps fill up space if you don't have much work experience
 - Don't include High School clubs
- Achievements**
 - Awards
 - Academic Distinctions, ie. Studio awards
 - Scholarships, even Entrance Scholarships
 - International Experience Awards
- Include dates!**





✉ dvrabke@uwaterloo.ca
☎ 647-515-7706

Hello! I'm Dani,

Work Experience

- Jan. 2022 – Apr. 2022** **MGBA**
Vancouver, BC
Architectural Intern
 - Developed Rezoning and Development Permit drawing packages for a new condo, including calculating FSR, iterating massing models, and drawing unit plans.
 - Created Revit models from scratch
- Jan. 2021 – Aug. 2021** **Architecture49**
Montréal, QC
Étudiante en Architecture
 - Worked fluently in French.
 - Solely responsible for modeling a major industrial building in Revit.
 - BIM (Building Information Modeling) and data manager for cost estimating.
 - Collaborated with architects and six teams of engineering consultants.
- Sept. 2019 – Dec. 2019** **HLW**
New York, NY
Interior Design Intern
 - Worked on SD, DD, and CA phases on office renovation projects.
 - Built Revit models from CAD drawings, drew construction details, and made Enscape renders
 - Compiled furniture bid packages and finish sample boards for clients.
- Jan. 2019 – Apr. 2019** **Architecture 49**
Toronto, ON
Architectural Assistant
 - Rendered images in Vray for transportation projects.
 - Developed an Accessibility for Ontarians with Disabilities Act (AODA) Compliance Checklist.
 - Held meetings with product and material representatives.

Relevant Skills

| Software | Fabrication | Languages |
|----------------------------|-------------------|------------------|
| — Revit | Physical Modeling | English (fluent) |
| — Enscape | Hand Drafting | French (working) |
| — Rhinoceros | Laser Cutting | |
| — Vray | CNC Milling | |
| — AutoCAD | 3D Printing | |
| — SketchUp | Woodworking | |
| — Adobe Ps, Ai, Id, Lr, Pr | | |

Education

- Sept. 2022 – Present** **University of Waterloo**
Cambridge, ON
Master of Architecture
- Sept. 2017 – Aug. 2022** **University of Waterloo**
Cambridge, ON
Bachelor of Architectural Studies Honors Co-Op

Leadership Involvement

- Sept. 2022 – Present** **BRIDGE Centre for Architecture + Design**
Cambridge, ON
Director
 - Coordinate, structure, organize, and run the student-run initiative striving to bridge the gap between the School of Architecture and the community of Cambridge, ON.
- Sept. 2022 – Present** **Mentorship for Architecture Peers**
Cambridge, ON
Mentor
 - Discuss academic and professional matters, recommend and refer them to campus resources, and promote healthy mentalities toward school.
 - Mentoring 1 group of first-year undergraduate and 1 group of first-year graduate students to aid their transition into the Waterloo Architecture community
- Sept. 2022 – Present** **We Climb (fake) Rocks - Recreational Climbing Club**
Cambridge, ON
Organizer
- Sept. 2021 – Present** **Waterloo Architecture Christian Fellowship**
Cambridge, ON
Coordinator
- Sept. 2021 – Dec. 2021** **Waterloo Architecture Students Association**
Cambridge, ON
President
 - Coordinate and delegate roles within the Undergraduate Student Council.
 - Represent the student body to Cambridge community, faculty, and staff.
- Jan. 2020 – Apr. 2020** **Waterloo Architecture Students Association**
Cambridge, ON
President
 - Coordinate and delegate roles within the Undergraduate Student Council.
 - Represent the student body to Cambridge community, faculty, and staff.
- May 2019 – Aug. 2019** **Iconography Play: Leviathan**
Cambridge, ON
Producer
 - In ARCH 248 curriculum, I coordinated all 15 production teams, ensured completion on time, delegated tasks, resolved conflicts, and overall, kept spirits up.
- Jan. 2018 – Present** **BRIDGE Centre for Architecture + Design**
Cambridge, ON
Social Media Coordinator + Published Author
 - Plan, post, and monitor BRIDGE's Instagram.
 - Publish articles and photograph events.
- Nov. 2018 – Sept. 2019** **University Of Waterloo: Waterloo Orientation Team**
Cambridge, ON
Architecture Orientation Coordinator
 - Accountable for executing Architecture Orientation 2019, through budgeting, hiring leaders, monitoring, and surveying.
 - Successfully make our students feel a part of the faculty of Engineering despite being a satellite campus from the University of Waterloo.
- Sept. 2018 – Aug. 2019** **Waterloo Architecture Students Association**
Cambridge, ON
Class Representative
 - Facilitate communication between class and faculty.
 - Voice class' concerns, suggestions, and questions.

Achievements

- Aug. 2022** **Honors with Distinction** graduation at University of Waterloo
- Sept. 2021** **Recipient of the Jim Kalbfleisch Award**
- Aug. 2020** **First Place** in BREWED Competition hosted by uni.yz
- Feb. 2020** **Finalist** in Expand Your Empire Case Competition
- May 2019** **Best Original Design** in Construction Toronto
- July 2018** **Employee of the Month** at Journeys
- Sept. 2017 - Aug. 2022** **Excellent Academic Standing** at University of Waterloo

- Descriptions:
 - Short and to the point
 - Start with verbs! “Action Words”
 - Like “coordinate”, “manage”, “create”, “developed”
 - NOT “I” SENTENCES
 - Emphasize your contributions
 - If it’s not necessary, don’t include!





dvgrabke@uwaterloo.ca
647-515-7706

Hello! I'm Dani,

Work Experience

Jan. 2022 – Apr. 2022
Vancouver, BC

MGBA
Architectural Intern

- Developed Rezoning and Development Permit drawing packages for a new condo, including calculating FSR, iterating massing models, and drawing unit plans.
- Created Revit models from scratch

Jan. 2021 – Aug. 2021
Montréal, QC

Architecture49
Étudiante en Architecture

- Worked fluently in French.
- Solely responsible for modeling a major industrial building in Revit.
- BIM (Building Information Modeling) and data manager for cost estimating.
- Collaborated with architects and six teams of engineering consultants.

Sept. 2019 – Dec. 2019
New York, NY

HLW
Interior Design Intern

- Worked on SD, DD, and CA phases on office renovation projects.
- Built Revit models from CAD drawings, drew construction details, and made Enscape renders
- Compiled furniture bid packages and finish sample boards for clients.

Jan. 2019 – Apr. 2019
Toronto, ON

Architecture 49
Architectural Assistant

- Rendered images in Vray for transportation projects.
- Developed an Accessibility for Ontarians with Disabilities Act (AODA) Compliance Checklist.
- Held meetings with product and material representatives.

Relevant Skills

| Software | Fabrication | Languages |
|--------------------------|-------------------|------------------|
| Revit | Physical Modeling | English (fluent) |
| Enscape | Hand Drafting | French (working) |
| Rhinoceros | | |
| Wway | Laser Cutting | |
| AutoCAD | CNC Milling | |
| SketchUp | 3D Printing | |
| Adobe Ps, Ai, Id, Lr, Pr | Woodworking | |

Education

Sept. 2022 – Present
Cambridge, ON

University of Waterloo
Master of Architecture

Sept. 2017 – Aug. 2022
Cambridge, ON

University of Waterloo
Bachelor of Architectural Studies Honors Co-Op

Leadership Involvement

Sept. 2022 – Present
Cambridge, ON

BRIDGE Centre for Architecture + Design
Director

- Coordinate, structure, organize, and run the student-run initiative striving to bridge the gap between the School of Architecture and the community of Cambridge, ON.

Sept. 2022 – Present
Cambridge, ON

Mentorship for Architecture Peers
Mentor

- Discuss academic and professional matters, recommend and refer them to campus resources, and promote healthy mentalities toward school.
- Mentoring 1 group of first-year undergraduate and 1 group of first-year graduate students to aid their transition into the Waterloo Architecture community

Sept. 2022 – Present
Cambridge, ON

We Climb (fake) Rocks - Recreational Climbing Club
Organizer

Sept. 2021 – Present
Cambridge, ON

Waterloo Architecture Christian Fellowship
Coordinator

Sept. 2021 – Dec. 2021
Jan. 2020 – Apr. 2020

Waterloo Architecture Students Association
President

- Coordinate and delegate roles within the Undergraduate Student Council. Represent the student body to Cambridge community, faculty, and staff.

May 2019 – Aug. 2019
Cambridge, ON

Iconography Play: Leviathan
Producer

- In ARCH 248 curriculum, I coordinated all 15 production teams, ensured completion on time, delegated tasks, resolved conflicts, and overall, kept spirits up.

Jan. 2018 – Present
Cambridge, ON

BRIDGE Centre for Architecture + Design
Social Media Coordinator + Published Author

- Plan, post, and monitor BRIDGE's Instagram.
- Publish articles and photograph events.

Nov. 2018 – Sept. 2019
Cambridge, ON

University Of Waterloo: Waterloo Orientation Team
Architecture Orientation Coordinator

- Accountable for executing Architecture Orientation 2019, through budgeting, hiring leaders, monitoring, and surveying.
- Successfully make our students feel a part of the faculty of Engineering despite being a satellite campus from the University of Waterloo.

Sept. 2018 – Aug. 2019
Cambridge, ON

Waterloo Architecture Students Association
Class Representative

- Facilitate communication between class and faculty.
- Voice class' concerns, suggestions, and questions.

Achievements

Aug. 2022

Honors with Distinction graduation at University of Waterloo

Sept. 2021

Recipient of the Jim Kalbfleisch Award

Aug. 2020

First Place in BREWED Competition hosted by uni.xyz

Feb. 2020

Finalist in Expand Your Empire Case Competition

May 2019

Best Original Design in Construction Toronto

July 2018

Employee of the Month at Journeys

Sept. 2017 – Aug. 2022

Excellent Academic Standing at University of Waterloo

Optional to include:

- **Skill Scale**
 - **Pro:** Visually communicates your skills; Shows off your level of expertise; Good if you're hoping to work on a specific software
 - **Con:** Admits low level of expertise; Balancing between being humble and bragging



Danielle Grabke

@ dvgrabke@uwaterloo.ca
647-515-7706

Work Experience

- Jan. 2022 – Apr. 2022
Vancouver, BC
MGBA
Architectural Intern
Developed Rezoning and Development Permit drawing packages
Calculating FSR, iterating massing models, and drawing unit plans
Created Revit models from scratch
- Jan. 2021 – Aug. 2021
Montréal, QC
Architecture99 - Montréal
Etudiante Architecte
Solely responsible for modeling and managing the Revit model for a major industrial building, BIM and data manager for cost estimating. Collaborated with architects and six teams of engineering consultants fluently in French.
- Sept. 2019 – Dec. 2019
New York, NY
HIW
Interior Design Intern
Worked on SD, DD, and CA phases on a variety of office renovation projects. Built Revit models from CAD drawings, drew construction details. Compiled furniture bid packages, finish sample boards, made renders for clients.
- Jan. 2019 – Apr. 2019
Toronto, ON
Architecture99 - Toronto
Architectural Assistant
Focused on transportation projects; creating renderings in Vray, construction details in Revit. Developed ADA Compliance Checklist. Held meetings with product and material representatives.

Leadership Involvement

- Sept. 2022 – Present
Cambridge, ON
BRIDGE Centre for Architecture + Design
Director
- Jan. 2020 – Dec. 2021
Cambridge, ON
Waterloo Architecture Students Association
President
- Jan. 2018 – Present
Cambridge, ON
BRIDGE Centre for Architecture + Design
Social Media Coordinator + Published Author
- Nov. 2018 – Sept. 2019
Cambridge, ON
University Of Waterloo
Architecture Orientation Committee
- May 2019 – Aug. 2019
Cambridge, ON
Iconography Play: Leviathan
Producer
- Sept. 2018 – Aug. 2019
Cambridge, ON
Waterloo Architecture Students Association
Class Representative

Education

- Sept. 2022 – Present
Cambridge, ON
University of Waterloo
Master of Architecture
- Sept. 2017 – Aug. 2022
Cambridge, ON
University of Waterloo
Bachelor of Architectural Studies Honors Co-Op

Relevant Skills

- Software**
Revit (BIM)
Enscape
RhinoCeros
Vray
AutoCAD
SketchUp
Adobe Ps, Ai, Id, Lr, Pr
- Fabrication**
Physical Modeling
Hand Drafting
Laser Cutting
CNC Milling
3D Printing
Woodworking
- Languages**
English (fluent)
French (intermediate)

Achievements

- Aug. 2022
Honors with Distinction |
Graduation at University of Waterloo
- Sept. 2021
Recipient |
of the Jim Kalbfleisch Award
- Aug. 2020
Winner |
BREWED Cafe Design Competition
- Feb. 2020
Finalist |
Expand Your Empire Case Competition
- May 2019
Best Original Design |
Construction Toronto
- July 2018
Employee of the Month |
Journeys Canada
- Sept. 2017 - Aug. 2022
Excellent Academic Standing |
University of Waterloo

A GOOD RESUME:

- Similar to CV, but ONE PAGE
- Clear layout
 - Text hierarchy
 - Visual Breaks
 - Succinct descriptions
 - Consistent margins and spaces
- Relevant Content
- ! This is the first thing an employer will look at

Danielle Grabke

@ dvgrabke@uwaterloo.ca
647-515-7706

Work Experience

Jan. 2022 – Apr. 2022
Vancouver, BC
MGBA
Architectural Intern
Developed Rezoning and Development Permit drawing packages
Calculating FSR, iterating massing models, and drawing unit plans
Created Revit models from scratch

Jan. 2021 – Aug. 2021
Montréal, QC
Architecture99 - Montréal
Etudiante Architecte
Solely responsible for modeling and managing the Revit model for a major industrial building, BIM and data manager for cost estimating. Collaborated with architects and six teams of engineering consultants fluently in French.

Sept. 2019 – Dec. 2019
New York, NY
HIW
Interior Design Intern
Worked on SD, DD, and CA phases on a variety of office renovation projects. Built Revit models from CAD drawings, drew construction details. Compiled furniture bid packages, finish sample boards, made renders for clients.

Jan. 2019 – Apr. 2019
Toronto, ON
Architecture99 - Toronto
Architectural Assistant
Focused on transportation projects; creating renderings in Vray, construction details in Revit. Developed ADA Compliance Checklist. Held meetings with product and material representatives.

Leadership Involvement

Sept. 2022 – Present
Cambridge, ON
BRIDGE Centre for Architecture + Design
Director

Jan. 2020 – Dec. 2021
Cambridge, ON
Waterloo Architecture Students Association
President

Jan. 2018 – Present
Cambridge, ON
BRIDGE Centre for Architecture + Design
Social Media Coordinator + Published Author

Nov. 2018 – Sept. 2019
Cambridge, ON
University Of Waterloo
Architecture Orientation Committee

May 2019 – Aug. 2019
Cambridge, ON
Iconography Play: Leviathan
Producer

Sept. 2018 – Aug. 2019
Cambridge, ON
Waterloo Architecture Students Association
Class Representative

Education

Sept. 2022 – Present
Cambridge, ON
University of Waterloo
Master of Architecture

Sept. 2017 – Aug. 2022
Cambridge, ON
University of Waterloo
Bachelor of Architectural Studies Honors Co-Op

Relevant Skills

Software
Revit (BIM)
Enscape
RhinoCeros
Vray
AutoCAD
SketchUp
Adobe Ps, Ai, Id, Lr, Pr

Fabrication
Physical Modeling
Hand Drafting
Laser Cutting
CNC Milling
3D Printing
Woodworking

Languages
English (fluent)
French (intermediate)

Achievements

Aug. 2022
Honors with Distinction |
Graduation at University of Waterloo

Sept. 2021
Recipient |
of the Jim Kalbfleisch Award

Aug. 2020
Winner |
BREWED Cafe Design Competition

Feb. 2020
Finalist |
Expand Your Empire Case Competition

May 2019
Best Original Design |
Construction Toronto

July 2018
Employee of the Month |
Journeys Canada

Sept. 2017 - Aug. 2022
Excellent Academic Standing |
University of Waterloo

- One page
- Full name on top
- No picture

Danielle Grabke

@ dvgrabke@uwaterloo.ca
647-515-7706

Work Experience

- Jan. 2022 – Apr. 2022
Vancouver, BC
MGBA
Architectural Intern
Developed Rezoning and Development Permit drawing packages
Calculating FSR, iterating massing models, and drawing unit plans
Created Revit models from scratch
- Jan. 2021 – Aug. 2021
Montréal, QC
Architecture99 - Montréal
Etudiante Architecte
Solely responsible for modeling and managing the Revit model for a major industrial building, BIM and data manager for cost estimating. Collaborated with architects and six teams of engineering consultants fluently in French.
- Sept. 2019 – Dec. 2019
New York, NY
HIW
Interior Design Intern
Worked on SD, DD, and CA phases on a variety of office renovation projects. Built Revit models from CAD drawings, drew construction details. Compiled furniture bid packages, finish sample boards, made renders for clients.
- Jan. 2019 – Apr. 2019
Toronto, ON
Architecture99 - Toronto
Architectural Assistant
Focused on transportation projects; creating renderings in Vray, construction details in Revit. Developed ADA Compliance Checklist. Held meetings with product and material representatives.

Leadership Involvement

- Sept. 2022 – Present
Cambridge, ON
BRIDGE Centre for Architecture + Design
Director
- Jan. 2020 – Dec. 2021
Cambridge, ON
Waterloo Architecture Students Association
President
- Jan. 2018 – Present
Cambridge, ON
BRIDGE Centre for Architecture + Design
Social Media Coordinator + Published Author
- Nov. 2018 – Sept. 2019
Cambridge, ON
University Of Waterloo
Architecture Orientation Committee
- May 2019 – Aug. 2019
Cambridge, ON
Iconography Play: Leviathan
Producer
- Sept. 2018 – Aug. 2019
Cambridge, ON
Waterloo Architecture Students Association
Class Representative

Education

- Sept. 2022 – Present
Cambridge, ON
University of Waterloo
Master of Architecture
- Sept. 2017 – Aug. 2022
Cambridge, ON
University of Waterloo
Bachelor of Architectural Studies Honors Co-Op

Relevant Skills

- Software**
Revit (BIM)
Enscape
RhinoCeros
Vray
AutoCAD
SketchUp
Adobe Ps, Ai, Id, Lr, Pr
- Fabrication**
Physical Modeling
Hand Drafting
Laser Cutting
CNC Milling
3D Printing
Woodworking
- Languages**
English (fluent)
French (intermediate)

Achievements

- Aug. 2022
Honors with Distinction |
Graduation at University of Waterloo
- Sept. 2021
Recipient |
of the Jim Kalbfleisch Award
- Aug. 2020
Winner |
BREWED Cafe Design Competition
- Feb. 2020
Finalist |
Expand Your Empire Case Competition
- May 2019
Best Original Design |
Construction Toronto
- July 2018
Employee of the Month |
Journeys Canada
- Sept. 2017 - Aug. 2022
Excellent Academic Standing |
University of Waterloo

- Remove descriptions for involvement
- Removed less important community involvement

lungs of steel

COMPETITION ENTRY

- 🕒 1 MONTH
- 👤 PERSONAL/COMPETITION
- 👥 GROUP W/ E.ZHANG

In the contemporary urban city, industry continues to prosper and manufacturing drives much of the second world economy. In countries like China or India, heavy industry blankets the sky with often times dense smog. Natural gases, coal, and carbon emissions are all major contributors; it is an intense air pollution with many risks to public health.

The key function of LUNGS OF STEEL addresses smog and urban pollution by creating a chamber that filters air. Located throughout the most critical smog zones in China, multiple towers may be built in one city. Since affected smog zones are primarily manufacturing towns, it is economical and sustainable to obtain locally sourced steel material. The light steel frame construction is a narrative on urban industrialization, while the colour gives the structure a playfulness akin to the works of Richard Rogers. Furthermore, as a moment of urban retreat, it becomes a space of meditation.

The CISC student competition is an annual themed competition by Canadian Institute of Steel Construction. With the given theme of "Tower", this competition entry uses the requirement of using steel by creating modular units with a focus on steel connections to create an experience that is able to contribute positively to its environment.



COMPETITION ENTRY

21

lungs of steel

lungs of steel

🕒 1 MONTH
👤 PERSONAL/COMPETITION
👥 GROUP W/ E.ZHANG

In the contemporary urban city, industry continues to prosper and manufacturing drives much of the second world economy. In countries like China or India, heavy industry blankets the sky with often times dense smog. Natural gases, coal, and carbon emissions are all major contributors; it is an intense air pollution with many risks to public health.

The key function of LUNGS OF STEEL addresses smog and urban pollution by creating a chamber that filters air. Located throughout the most critical smog zones in China, multiple towers may be built in one city. Since affected smog zones are primarily manufacturing towns, it is economical and sustainable to obtain locally sourced steel material. The light steel frame construction is a narrative on urban industrialization, while the colour gives the structure a playfulness akin to the works of Richard Rogers. Furthermore, as a moment of urban retreat, it becomes a space of meditation.

The CISC student competition is an annual themed competition by Canadian Institute of Steel Construction. With the given theme of "Tower", this competition entry uses the requirement of using steel by creating modular units with a focus on steel connections to create an experience that is able to contribute positively to its environment.



COMPETITION ENTRY

21

lungs of steel

A GOOD INTRODUCTION PAGE:

- Consistent layout
- Information is in the same place every time

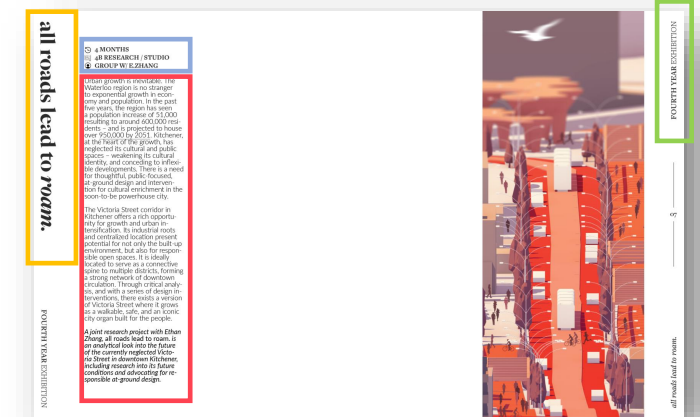

Anatomy of a Project Introduction Page



🕒 1 MONTH
 👤 PERSONAL/COMPETITION
 🏆 GROUP W/ E.ZHANG

In the contemporary urban city, industry continues to prosper and manufacturing drives much of the second world economy. In countries like China or India, heavy industry blankets the sky with often times dense smog. Natural gases, coal, and carbon emissions are all major contributors; it is an intense air pollution with many risks to public health.

The key function of LUNGS OF STEEL addresses smog and urban pollution by creating a chamber that filters air. Located throughout the most critical smog zones in China, multiple towers may be built in one city. Since affected smog zones are primarily manufacturing towns, it is economical and sustainable to obtain locally sourced steel material. The light steel frame construction is a narrative on urban industrialization, while the colour gives the structure a playfulness akin to the works of Richard Rogers. Furthermore, as a moment of urban retreat, it becomes a space of meditation.

The CISC student competition is an annual themed competition by Canadian Institute of Steel Construction. With the given theme of "Tower", this competition entry uses the requirement of using steel by creating modular units with a focus on steel connections to create an experience that is able to contribute positively to its environment.

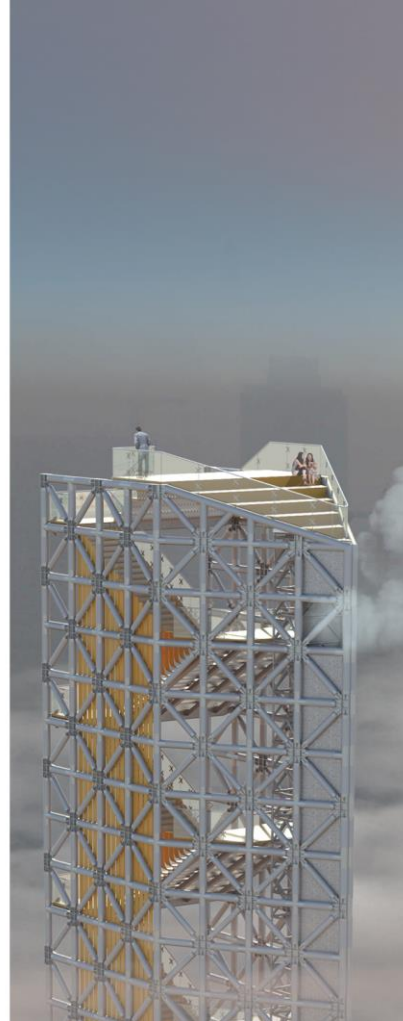

A GOOD INTRODUCTION PAGE:

- Consistent layout
 - Information is in the same place every time
- Clean layout
- Clear title

🕒 1 MONTH
 👤 PERSONAL/COMPETITION
 👥 GROUP W/ E.ZHANG

In the contemporary urban city, industry continues to prosper and manufacturing drives much of the second world economy. In countries like China or India, heavy industry blankets the sky with often times dense smog. Natural gases, coal, and carbon emissions are all major contributors; it is an intense air pollution with many risks to public health.

The key function of LUNGS OF STEEL addresses smog and urban pollution by creating a chamber that filters air. Located throughout the most critical smog zones in China, multiple towers may be built in one city. Since affected smog zones are primarily manufacturing towns, it is economical and sustainable to obtain locally sourced steel material. The light steel frame construction is a narrative on urban industrialization, while the colour gives the structure a playfulness akin to the works of Richard Rogers. Furthermore, as a moment of urban retreat, it becomes a space of meditation.

The CISC student competition is an annual themed competition by Canadian Institute of Steel Construction. With the given theme of "Tower", this competition entry uses the requirement of using steel by creating modular units with a focus on steel connections to create an experience that is able to contribute positively to its environment.



COMPETITION ENTRY

21

lungs of steel

- Project Title
- Should summarize your parti/project in one/a couple of words
- Does the title matter much? ˘(˘)˘

🕒 1 MONTH
👤 PERSONAL/COMPETITION
👥 GROUP W/ E.ZHANG

In the contemporary urban city, industry continues to prosper and manufacturing drives much of the second world economy. In countries like China or India, heavy industry blankets the sky with often times dense smog. Natural gases, coal, and carbon emissions are all major contributors; it is an intense air pollution with many risks to public health.

The key function of LUNGS OF STEEL addresses smog and urban pollution by creating a chamber that filters air. Located throughout the most critical smog zones in China, multiple towers may be built in one city. Since affected smog zones are primarily manufacturing towns, it is economical and sustainable to obtain locally sourced steel material. The light steel frame construction is a narrative on urban industrialization, while the colour gives the structure a playfulness akin to the works of Richard Rogers. Furthermore, as a moment of urban retreat, it becomes a space of meditation.

The CISC student competition is an annual themed competition by Canadian Institute of Steel Construction. With the given theme of "Tower", this competition entry uses the requirement of using steel by creating modular units with a focus on steel connections to create an experience that is able to contribute positively to its environment.



COMPETITION ENTRY

21

lungs of steel

Nice to have:

- Subheading
- What kind of project is this? What year was this made in? Competition?
- Information at a glance

🕒 1 MONTH
👤 PERSONAL/COMPETITION
👥 GROUP W/ E.ZHANG

In the contemporary urban city, industry continues to prosper and manufacturing drives much of the second world economy. In countries like China or India, heavy industry blankets the sky with often times dense smog. Natural gases, coal, and carbon emissions are all major contributors; it is an intense air pollution with many risks to public health.

The key function of LUNGS OF STEEL addresses smog and urban pollution by creating a chamber that filters air. Located throughout the most critical smog zones in China, multiple towers may be built in one city. Since affected smog zones are primarily manufacturing towns, it is economical and sustainable to obtain locally sourced steel material. The light steel frame construction is a narrative on urban industrialization, while the colour gives the structure a playfulness akin to the works of Richard Rogers. Furthermore, as a moment of urban retreat, it becomes a space of meditation.

The CISC student competition is an annual themed competition by Canadian Institute of Steel Construction. With the given theme of "Tower", this competition entry uses the requirement of using steel by creating modular units with a focus on steel connections to create an experience that is able to contribute positively to its environment.



- Page number
- Or some indication where you are in the portfolio

Anatomy of a Project Introduction Page



🕒 1 MONTH
👤 PERSONAL/COMPETITION
👥 GROUP W/ E.ZHANG

In the contemporary urban city, industry continues to prosper and manufacturing drives much of the second world economy. In countries like China or India, heavy industry blankets the sky with often times dense smog. Natural gases, coal, and carbon emissions are all major contributors; it is an intense air pollution with many risks to public health.

The key function of LUNGS OF STEEL addresses smog and urban pollution by creating a chamber that filters air. Located throughout the most critical smog zones in China, multiple towers may be built in one city. Since affected smog zones are primarily manufacturing towns, it is economical and sustainable to obtain locally sourced steel material. The light steel frame construction is a narrative on urban industrialization, while the colour gives the structure a playfulness akin to the works of Richard Rogers. Furthermore, as a moment of urban retreat, it becomes a space of meditation.

The CISC student competition is an annual themed competition by Canadian Institute of Steel Construction. With the given theme of "Tower", this competition entry uses the requirement of using steel by creating modular units with a focus on steel connections to create an experience that is able to contribute positively to its environment.



- Eye-catching graphic of your project
- Enough to give intrigue to keep reading, but also give a good snapshot of the project

🕒 1 MONTH
 📄 PERSONAL/COMPETITION
 👤 GROUP W/ E.ZHANG

In the contemporary urban city, industry continues to prosper and manufacturing drives much of the second world economy. In countries like China or India, heavy industry blankets the sky with often times dense smog. Natural gases, coal, and carbon emissions are all major contributors; it is an intense air pollution with many risks to public health.

The key function of LUNGS OF STEEL addresses smog and urban pollution by creating a chamber that filters air. Located throughout the most critical smog zones in China, multiple towers may be built in one city. Since affected smog zones are primarily manufacturing towns, it is economical and sustainable to obtain locally sourced steel material. The light steel frame construction is a narrative on urban industrialization, while the colour gives the structure a playfulness akin to the works of Richard Rogers. Furthermore, as a moment of urban retreat, it becomes a space of meditation.

The CISC student competition is an annual themed competition by Canadian Institute of Steel Construction. With the given theme of "Tower", this competition entry uses the requirement of using steel by creating modular units with a focus on steel connections to create an experience that is able to contribute positively to its environment.



- Overview of Project
- Can be used instead of subheading
- Length of project time
- What purpose project was done (studio project? Competition? Personal?)
- Group members (if any)

🕒 1 MONTH
👤 PERSONAL/COMPETITION
👥 GROUP W/ E.ZHANG

In the contemporary urban city, industry continues to prosper and manufacturing drives much of the second world economy. In countries like China or India, heavy industry blankets the sky with often times dense smog. Natural gases, coal, and carbon emissions are all major contributors; it is an intense air pollution with many risks to public health.

The key function of LUNGS OF STEEL addresses smog and urban pollution by creating a chamber that filters air. Located throughout the most critical smog zones in China, multiple towers may be built in one city. Since affected smog zones are primarily manufacturing towns, it is economical and sustainable to obtain locally sourced steel material. The light steel frame construction is a narrative on urban industrialization, while the colour gives the structure a playfulness akin to the works of Richard Rogers. Furthermore, as a moment of urban retreat, it becomes a space of meditation.

The CISC student competition is an annual themed competition by Canadian Institute of Steel Construction. With the given theme of "Tower", this competition entry uses the requirement of using steel by creating modular units with a focus on steel connections to create an experience that is able to contribute positively to its environment.

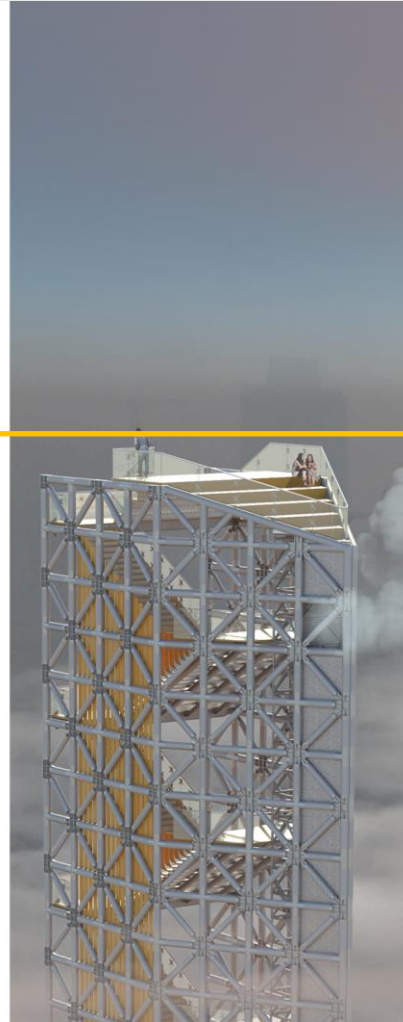

COMPETITION ENTRY

21

lungs of steel

- Description of Project

🕒 1 MONTH
 👤 PERSONAL/COMPETITION
 👥 GROUP W/ E.ZHANG

In the contemporary urban city, industry continues to prosper and manufacturing drives much of the second world economy. In countries like China or India, heavy industry blankets the sky with often times dense smog. Natural gases, coal, and carbon emissions are all major contributors; it is an intense air pollution with many risks to public health.

The key function of LUNGS OF STEEL addresses smog and urban pollution by creating a chamber that filters air. Located throughout the most critical smog zones in China, multiple towers may be built in one city. Since affected smog zones are primarily manufacturing towns, it is economical and sustainable to obtain locally sourced steel material. The light steel frame construction is a narrative on urban industrialization, while the colour gives the structure a playfulness akin to the works of Richard Rogers. Furthermore, as a moment of urban retreat, it becomes a space of meditation.

The CISC student competition is an annual themed competition by Canadian Institute of Steel Construction. With the given theme of "Tower", this competition entry uses the requirement of using steel by creating modular units with a focus on steel connections to create an experience that is able to contribute positively to its environment.



Nice to have:

- TL;DR of project
- If employer is skimming, may be nice to have a summary of the description. If it catches intrigue, may get them to read the description.
- Bolded, at the end (mine isn't bold enough!)



Anatomy of a Project Introduction Page

While the Lungs of Steel are designed for assembly in any cities that require air purification, an intended destination for Lung of Steel Towers is the city of TangShan in China. As one of the oldest industrial cities in the country and a leading exporter of steel, the residents in the city are left with high densities of smog on a daily basis. Being able to source the materiality locally would help mitigate needless carbon emission while positively impacting the quality of life of the local residents.

In the proposed site plan below, the towers are placed around the city in order to contain and purify carbon emissions. Through analyzing TangShan's annual wind studies, strategic placements for the towers have been located in areas where they would catch the greatest amount of air flow.

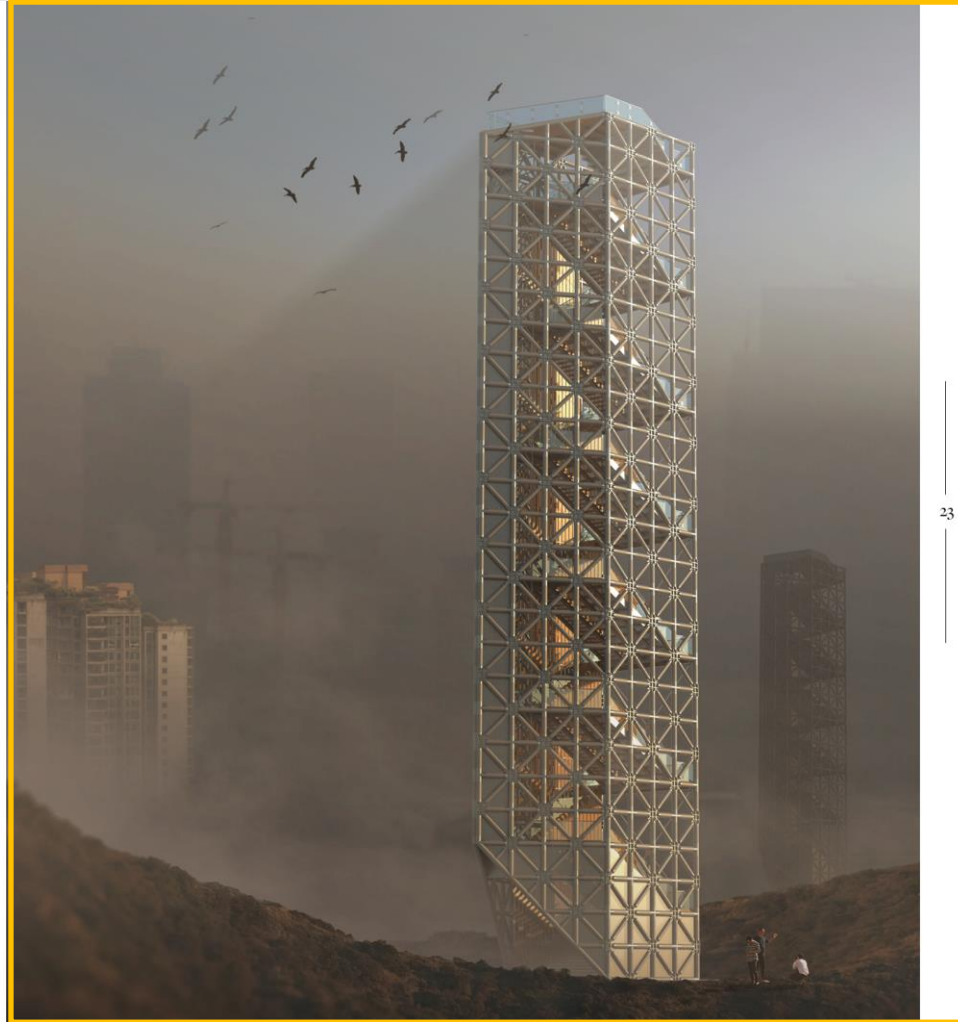

First page: overview of project.

- As someone's flipping through the project, what's the best image to use to allow them to understand what the project is/looks like?

While the Lungs of Steel are designed for assembly in any cities that require air purification, an intended destination for Lung of Steel Towers is the city of TangShan in China. As one of the oldest industrial cities in the country and a leading exporter of steel, the residents in the city are left with high densities of smog on a daily basis. Being able to source the materiality locally would help mitigate needless carbon emission while positively impacting the quality of life of the local residents.

In the proposed site plan below, the towers are placed around the city in order to contain and purify carbon emissions. Through analyzing TangShan's annual wind studies, strategic placements for the towers have been located in areas where they would catch the greatest amount of air flow.



- First page: any 'big picture' details, parti diagrams, etc. should come first.

While the Lungs of Steel are designed for assembly in any cities that require air purification, an intended destination for Lung of Steel Towers is the city of TangShan in China. As one of the oldest industrial cities in the country and a leading exporter of steel, the residents in the city are left with high densities of smog on a daily basis. Being able to source the materiality locally would help mitigate needless carbon emission while positively impacting the quality of life of the local residents.

In the proposed site plan below, the towers are placed around the city in order to contain and purify carbon emissions. Through analyzing TangShan's annual wind studies, strategic placements for the towers have been located in areas where they would catch the greatest amount of air flow.

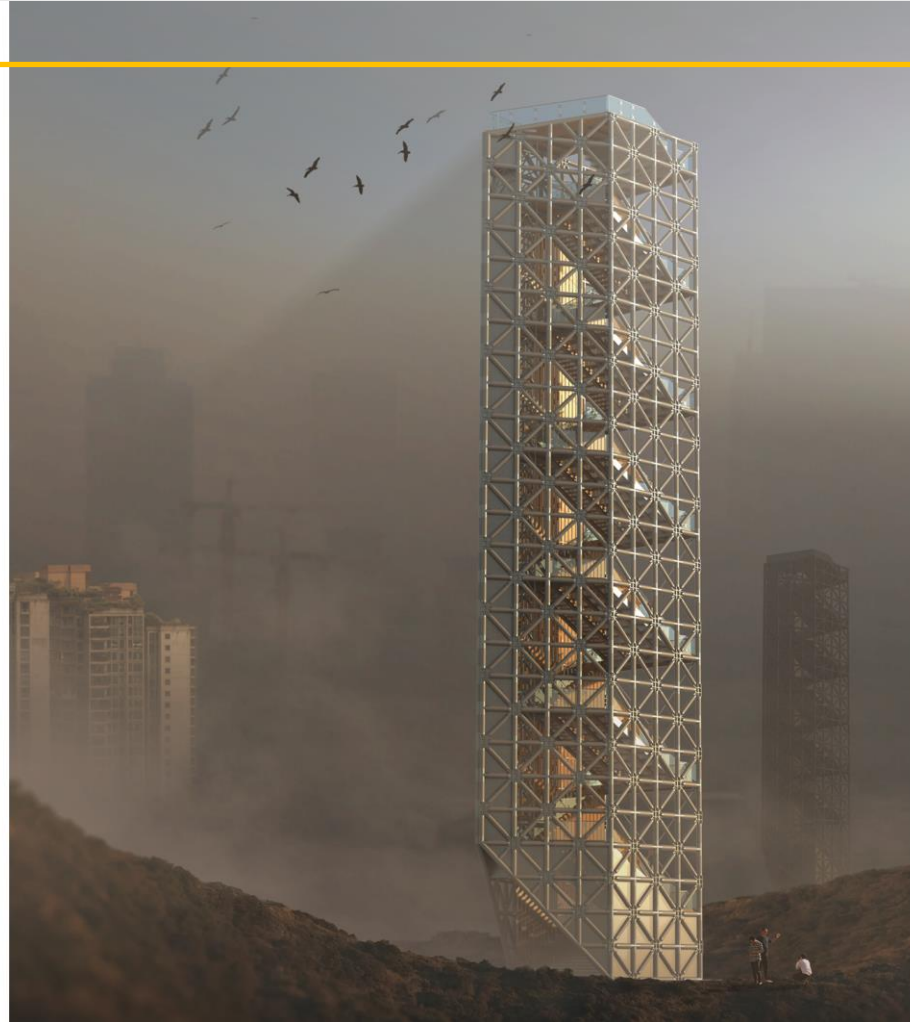

- Note: you can have text explain what's being shown on the page.
- **Do not expect your interviewers to read this text.**
 - They may if they are interested, likely will only read the introductory description.
- You can use text like this to add compositional elements to your spread.
- Use sparingly!! Do not overwhelm with text.

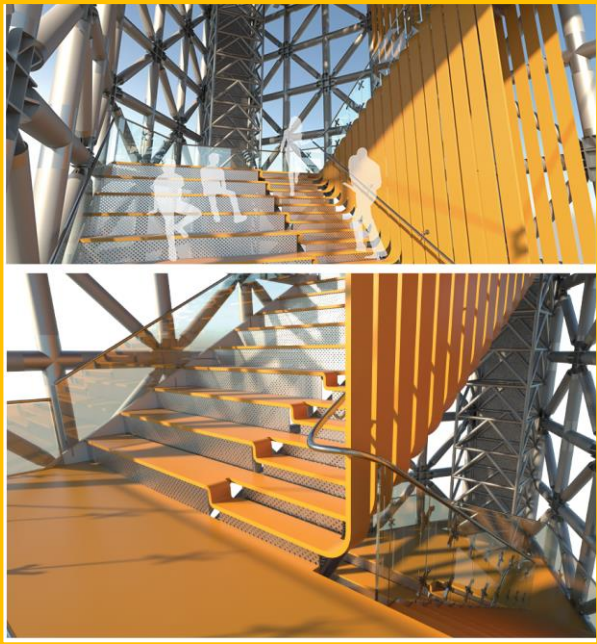

The filtration process uses convection as the key method of air purification. Intake vents near the base of the tower allows for air to flow into the structure. Within, the air is heated up by a generator and starts to ascend in this action, the air passes through multiple levels of filters to re-move larger particles. The finer particles attach to positive ions emitted by a positive current where it is then collected on a negatively charged surface. At the top where the open observation deck is, clean air emerges into the atmosphere.

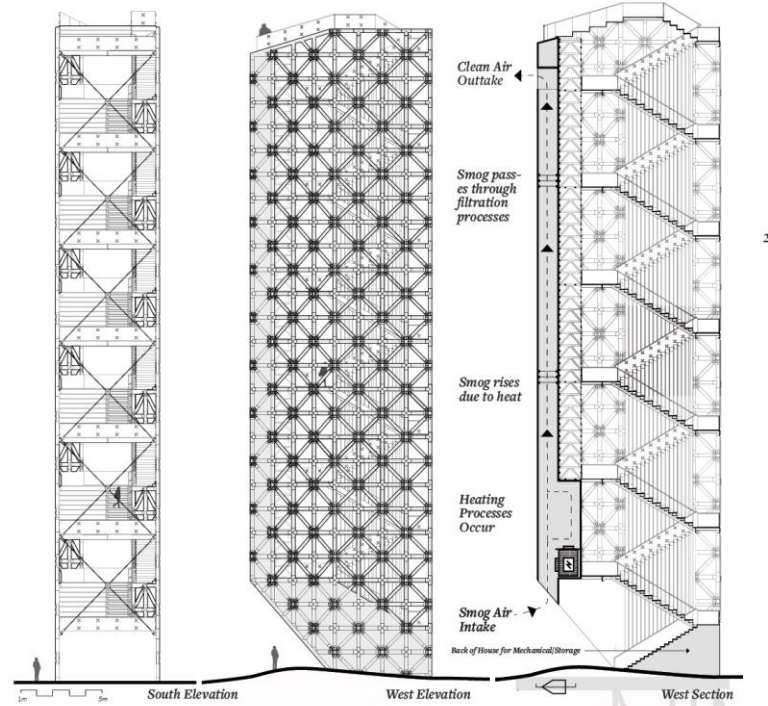

Subsequent pages:

- Images that explain your project in further detail
- Detail/interior Renders



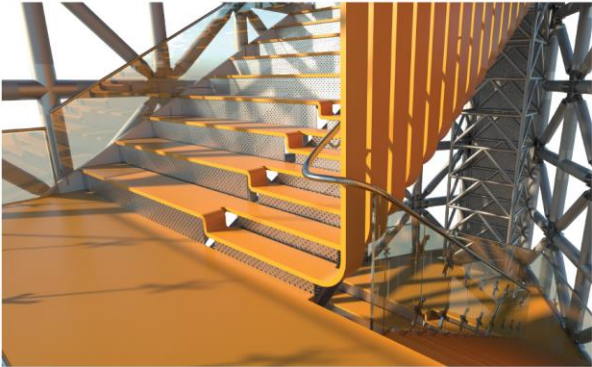
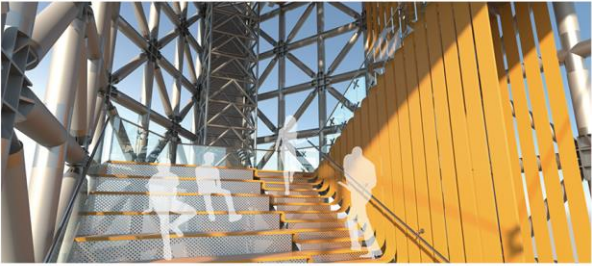

The filtration process uses convection as the key method of air purification. Intake vents near the base of the tower allows for air to flow into the structure. Within, the air is heated up by a generator and starts to ascend in this action, the air passes through multiple levels of filters to re-move larger particles. The finer particles attach to positive ions emitted by a positive current where it is then collected on a negatively charged surface. At the top where the open observation deck is, clean air emerges into the atmosphere.

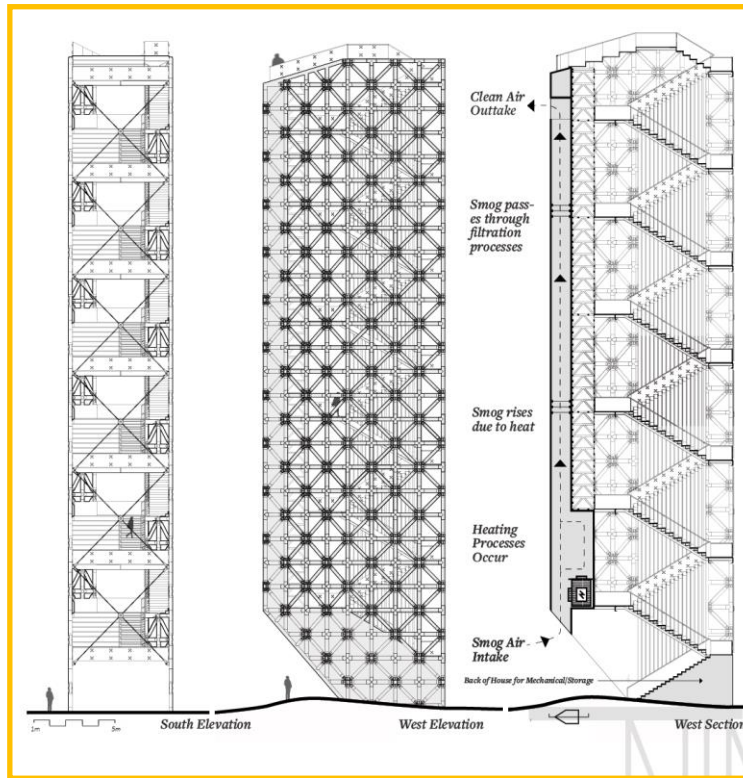

Subsequent pages:

- Orthographics that convey the project



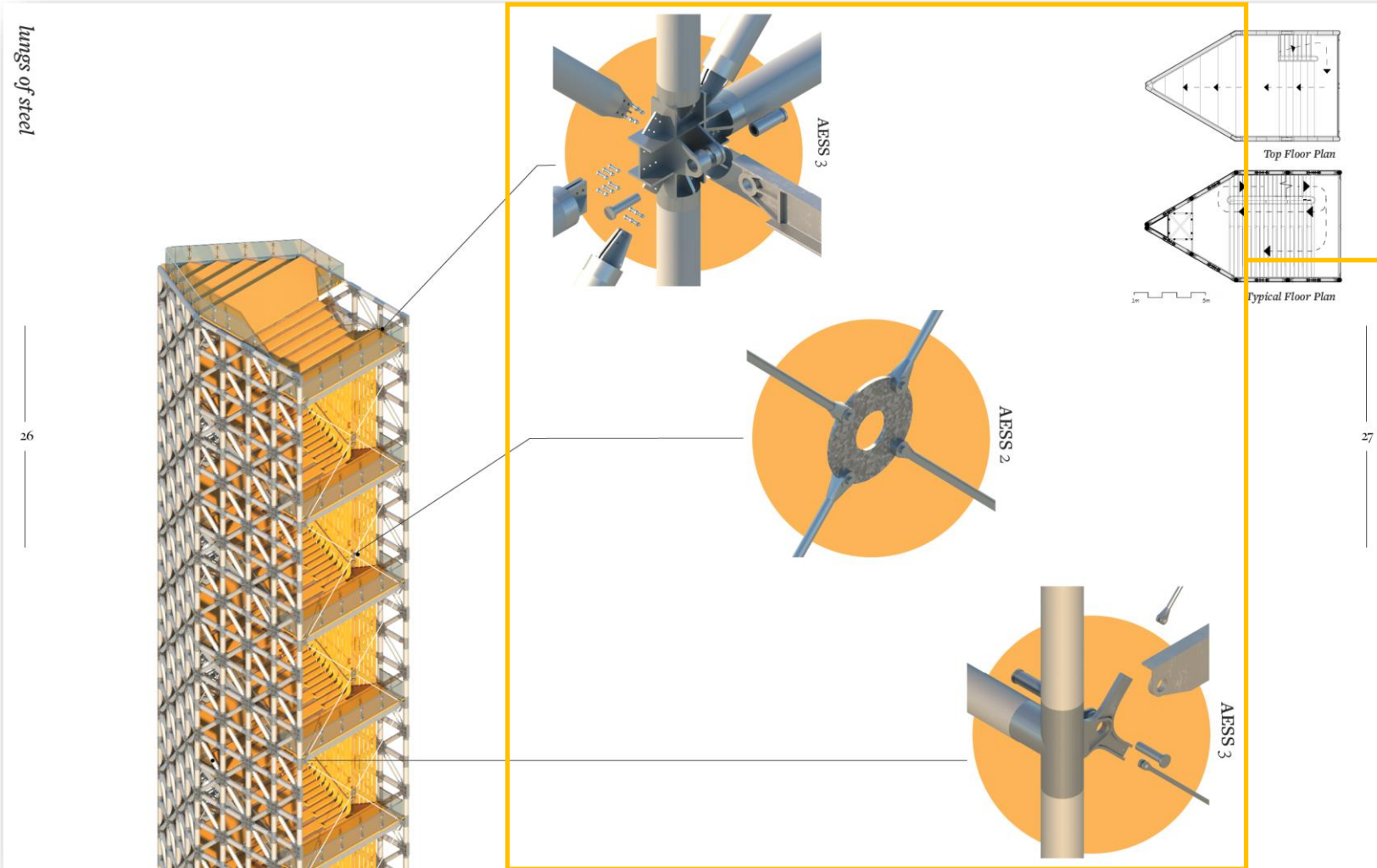

Last pages

- Specifics of your project
- Detailing, wall sections, etc.
- Note: if the detailing/technical aspects of your building is important to your design, **show them first, not last.**
- These pages should have **information you are okay with reviewers skipping over.**

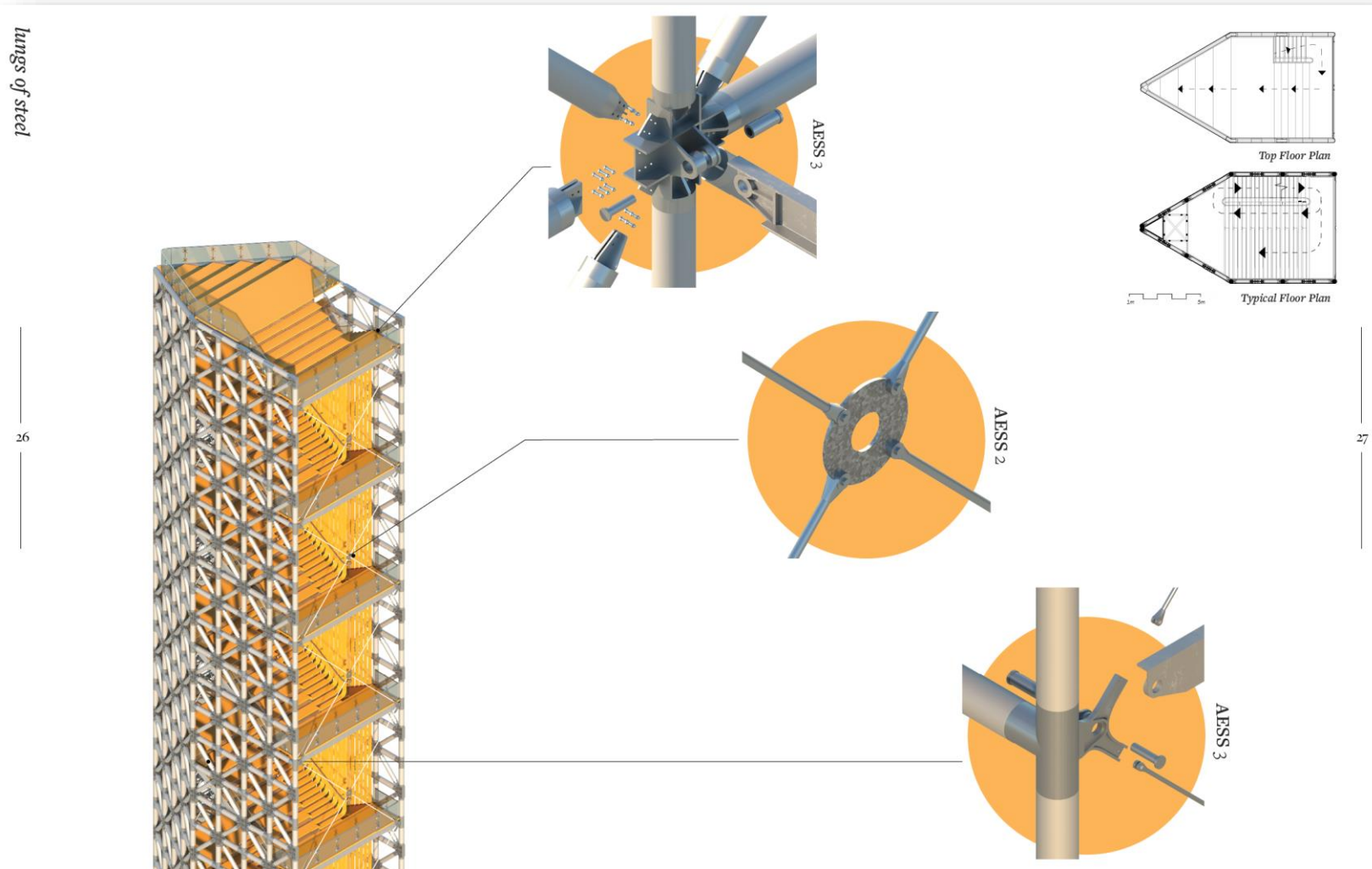

What skills does this project show off?

- Capable of modelling complex geometries
- Knowledge of steel connections + AESS distinctions
- Research oriented design
- Graphic capabilities
- Initiative taken to enter competitions beyond school!



3

Village Cafe

Located in Vienna, Austria, Village Cafe brings everyone together to enjoy a cup of coffee whether they prefer an espresso, a latte, or an iced coffee. The design splits the café into six different "houses", each offering various programmatic uses, offering a sense of agency in their surroundings. Each house is designed for specific gathering types, allowing the customer to have a sense of familiarity and control within each condition. Before stepping into these spaces, the individual passes under a glass canopy flanking the edges of each house. The continuous skylight offers a direct connection between human and nature while providing shelter from the elements. The houses, in turn, give a sense of home as it invites diverse customers to enjoy a cup of coffee.

August 2020
BREWED Competition
In collaboration with Chris Qiu
First Place Winner



3

Village Cafe

Located in Vienna, Austria, Village Cafe brings everyone together to enjoy a cup of coffee whether they prefer an espresso, a latte, or an iced coffee. The design splits the café into six different "houses", each offering various programmatic uses, offering a sense of agency in their surroundings. Each house is designed for specific gathering types, allowing the customer to have a sense of familiarity and control within each condition. Before stepping into these spaces, the individual passes under a glass canopy flanking the edges of each house. The continuous skylight offers a direct connection between human and nature while providing shelter from the elements. The houses, in turn, give a sense of home as it invites diverse customers to enjoy a cup of coffee.

August 2020
BREWED Competition
In collaboration with Chris Qiu
First Place Winner

- Different format but still includes necessary information:
 - Name
 - Description
 - Overview of project (when, why, with who)
 - If project won awards/was exhibited/part of a competition, mention it!

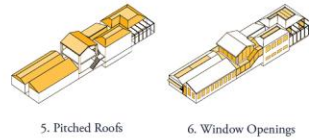
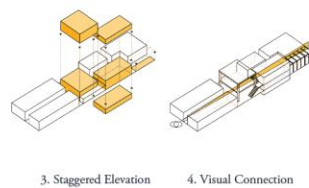
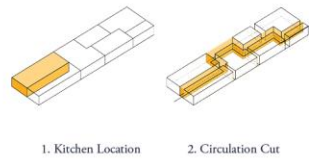
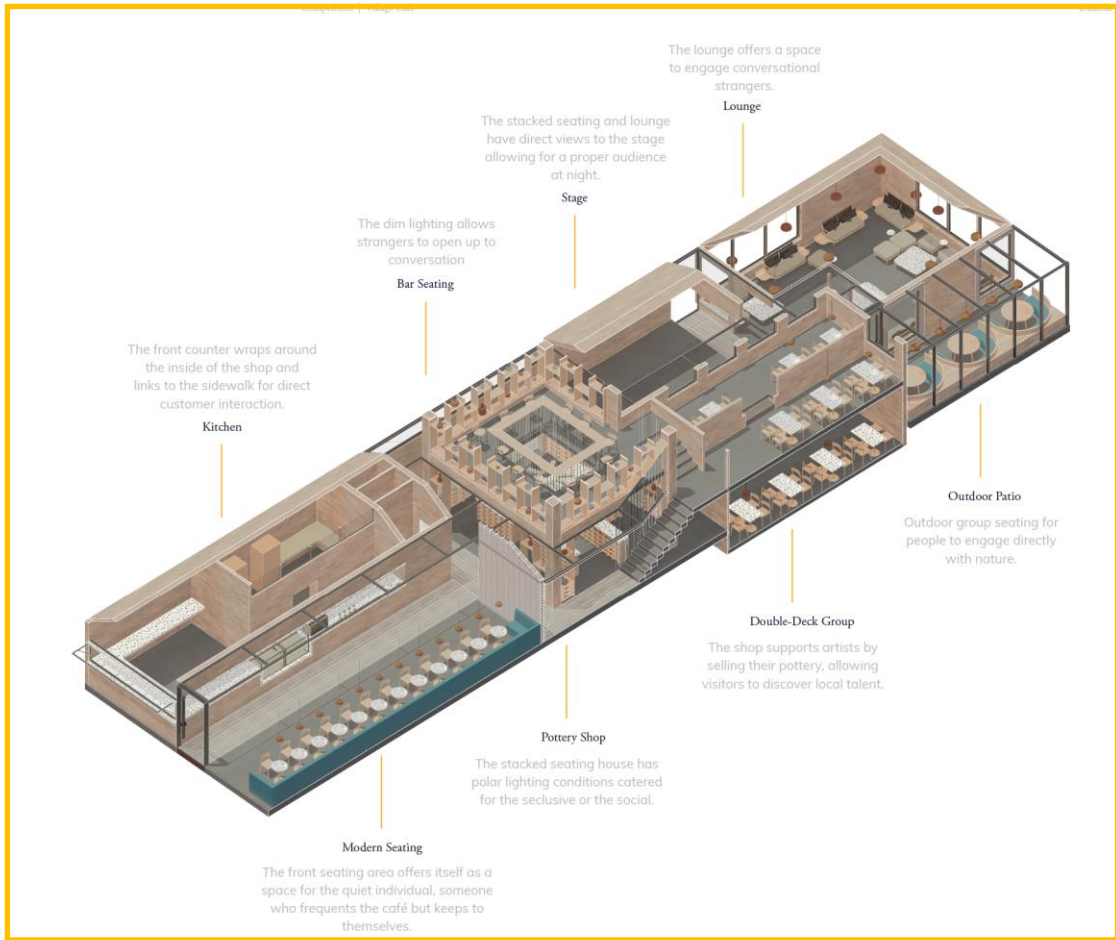

- Project focuses on circulation and components, **axo** best used!
 - (Also why we used axos for the parti diagram)



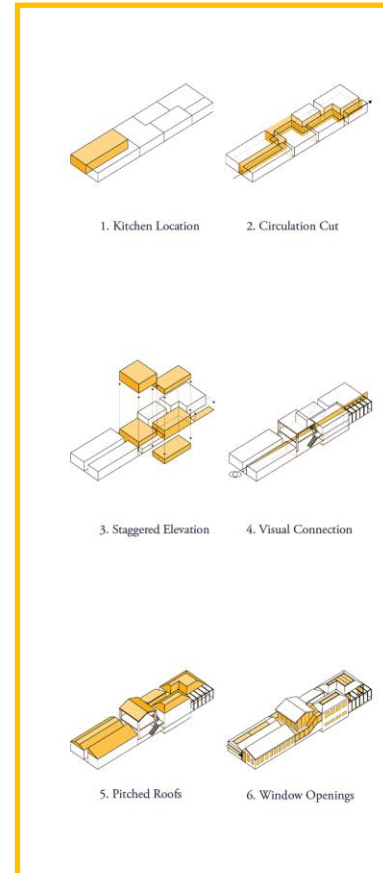
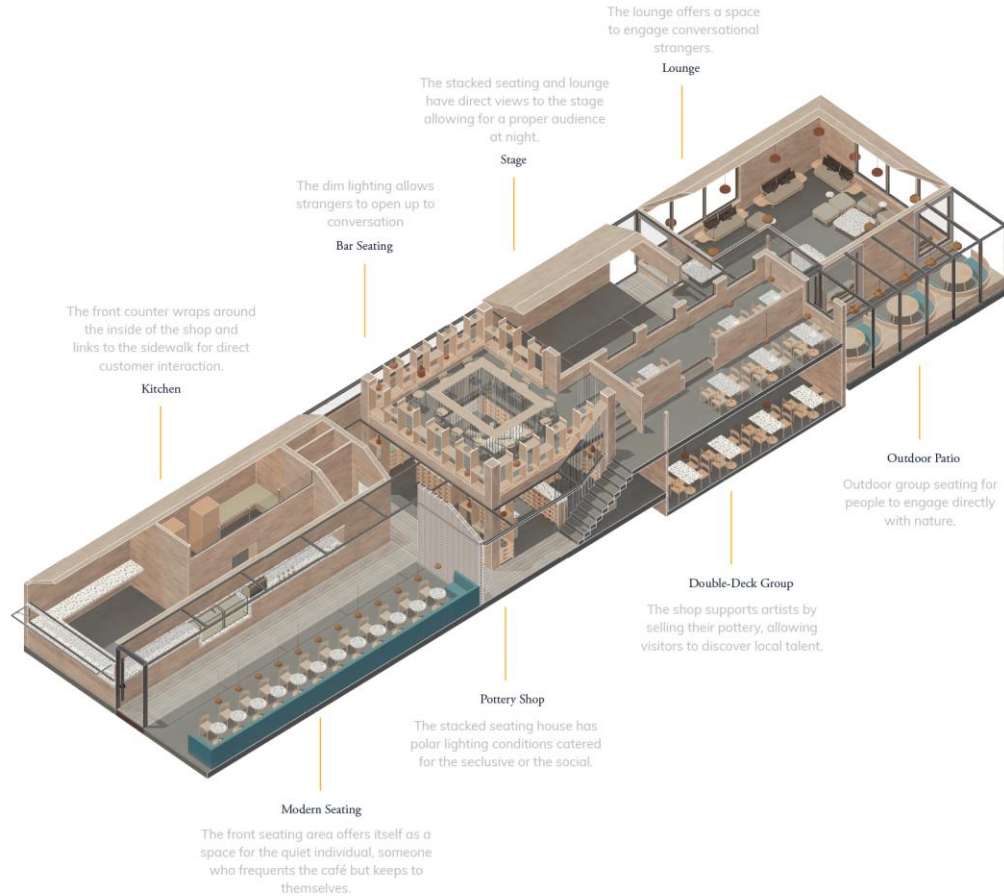

- Parti diagrams; good for explaining concept (especially without text)

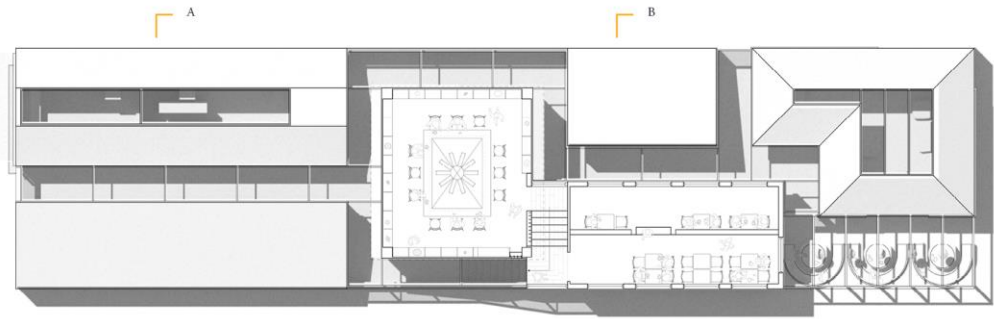

Second Floor

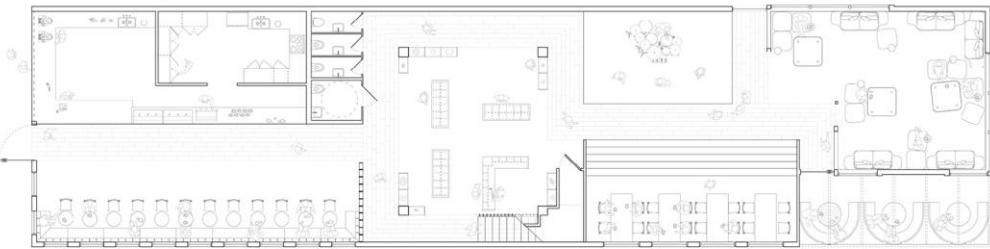

First Floor



Section BB

- Remember: it takes time to “read” plans/sections. Do not assume they can understand your plan right away!



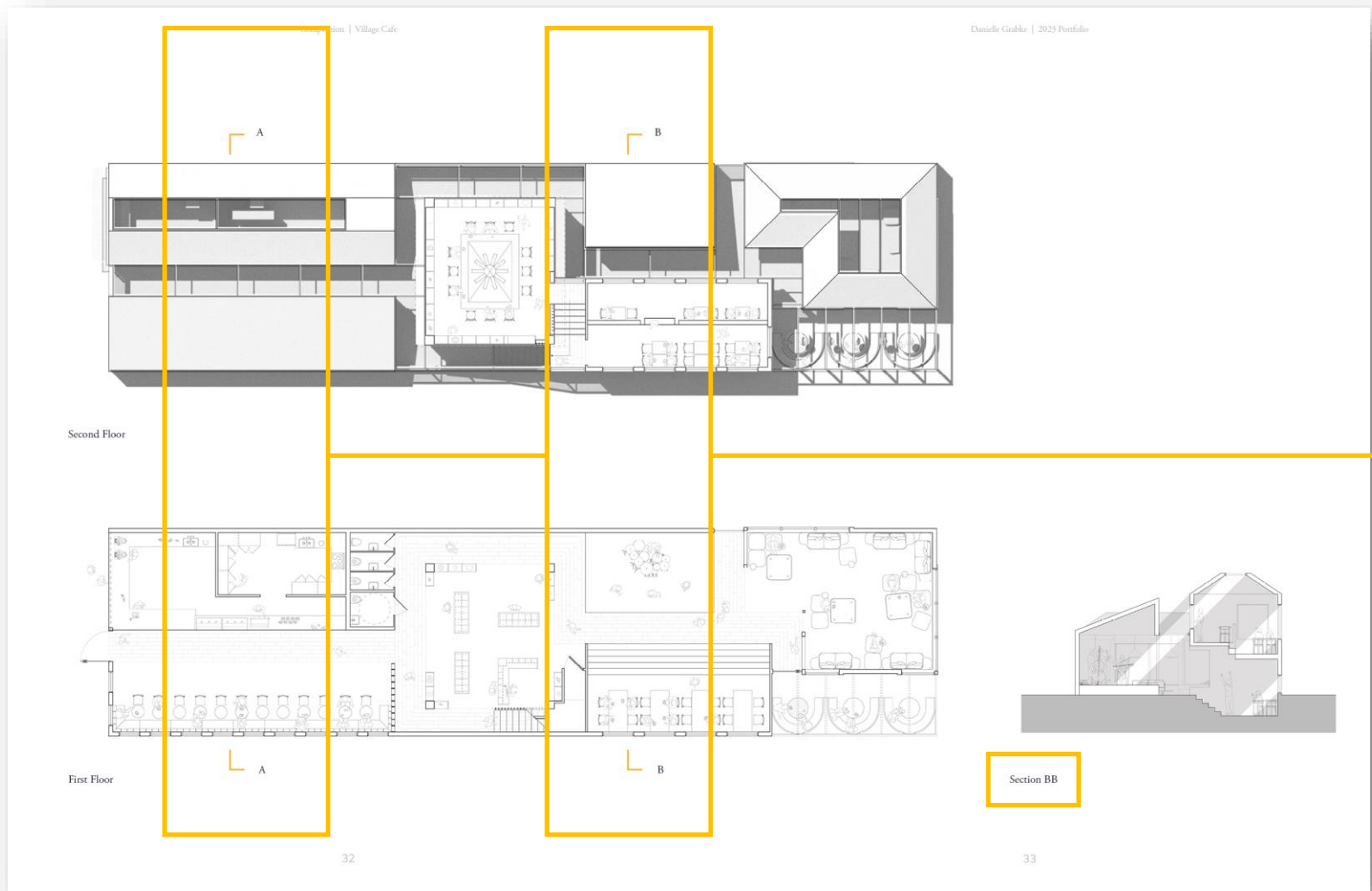

- Section cuts on plans: important!
Allows reader to reference where section is cut.
- Labelled (AA, BB)

Supporting Project Page – Explanation/Details



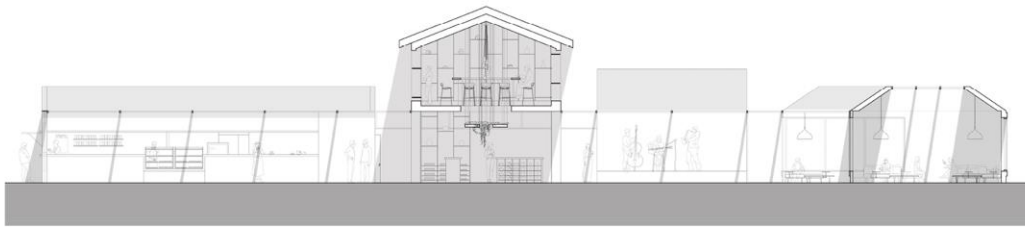

Long Section

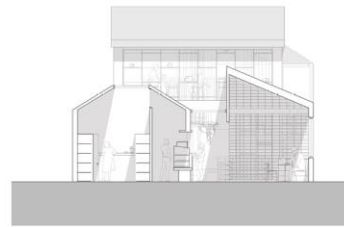

Section AA



Side Elevation



Front Elevation

- Sections on the same ground level aligned in spread
- **ADD A GAP** in the section line
 - Or else it would technically read like there are two buildings
 - **Even if it's obvious to you, it won't be obvious to someone else**

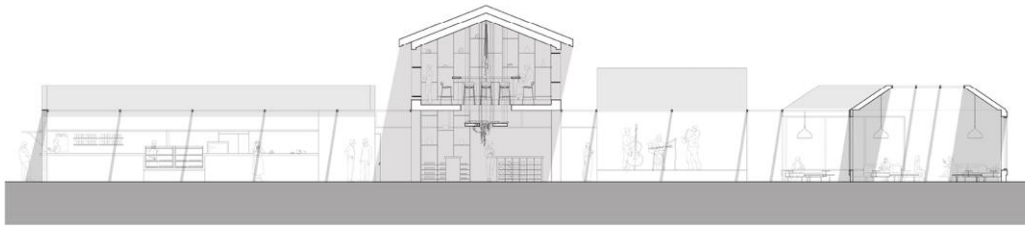

Long Section



Side Elevation

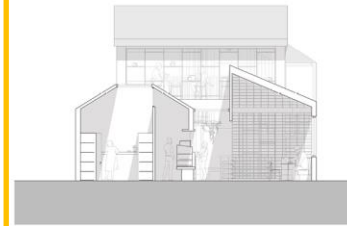

Section AA



Front Elevation

- Section + elevation aligned vertically – visually understand how this section is being cut and its relationship to the facade



Seating Area Material + Furniture Palette

Outdoor Patio Material + Furniture Palette

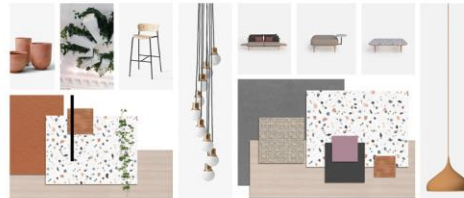

Pottery Shop Material + Furniture Palette

Lounge Material + Furniture Palette

- My partner worked on the renders, so I included them in a way that **brings emphasis to my contribution...** the material palette!



Seating Area Material + Furniture Palette

Outdoor Patio Material + Furniture Palette

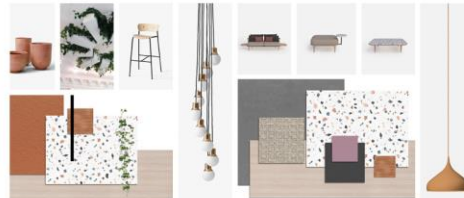

Pottery Shop Material + Furniture Palette

Lounge Material + Furniture Palette

What skills does this project show off?

- Competition winner – excel in design + graphics for competitions
 - Initiative taken to enter competitions beyond school
- Work with materiality + tectonics
- Solid grasp on plans, sections, elevations – attractive for firms

- 🕒 2ND YEAR – CURRENT
- 📁 PERSONAL/PROFESSIONAL WORK
- 👤 INDIVIDUAL

Additional selected works. Contains professional work from previous internship positions varying from 2018-2020, on projects I had participated on and my responsibilities within each role. For a more detailed description of my responsibilities, please refer to my portfolio.

In addition to my professional work, included are personal projects taken up for my self interest.

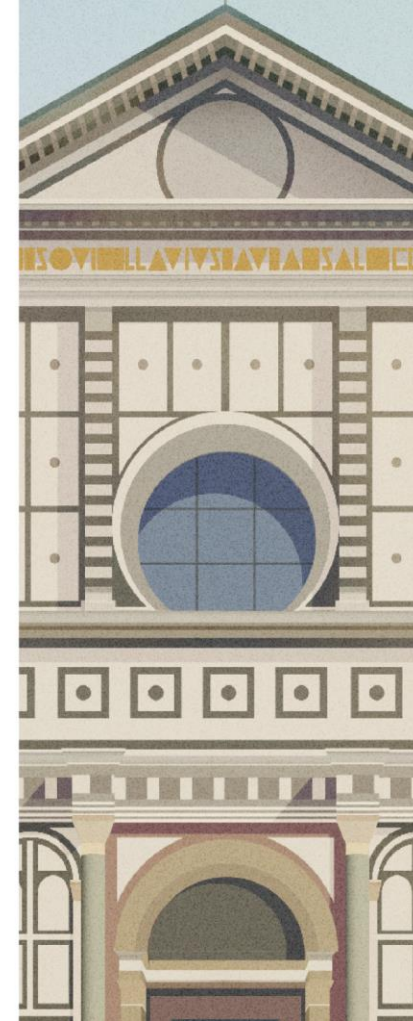

- 🕒 2ND YEAR – CURRENT
- 📁 PERSONAL/PROFESSIONAL WORK
- 👤 INDIVIDUAL

Additional selected works. Contains professional work from previous internship positions varying from 2018-2020, on projects I had participated on and my responsibilities within each role. For a more detailed description of my responsibilities, please refer to my portfolio.

In addition to my professional work, included are personal projects taken up for my self interest.

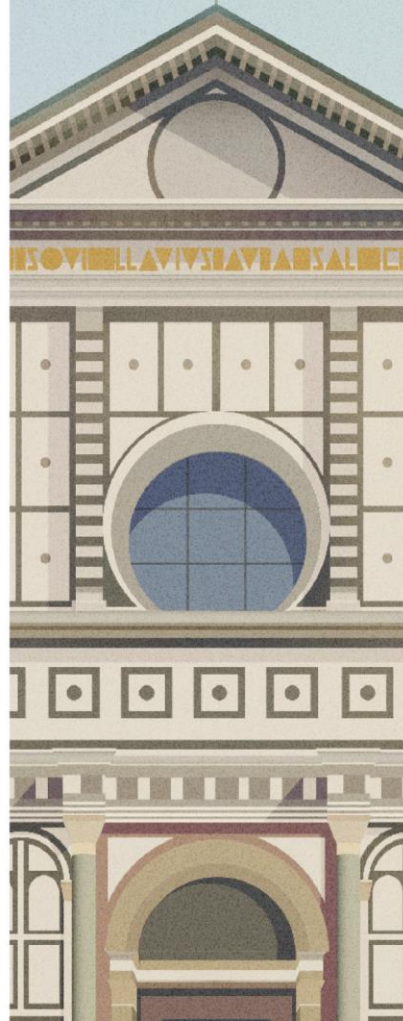

This section of portfolio serves a couple of functions:

- !! To show off skills that are transferable into the workplace !!
- To show your interests outside of architecture, meaning you take initiative to do things on your own and not just what is required
- Show your personality! Allows you to stand out.



Originally started as a sketchbook challenge done during my co-op term in NYC, a sketchbook log is kept during co-ops in the aims to fill full sketchbooks and thus learning how to draw. These are some exercises completed during my travels in my last two co-ops, including sketches from NYC, Paris, and Prague.

SKETCHES



sketch of house
15 MAY
02:11 PM
METZGERSHAIN MARCH
07:02



- **Function this serves:** demonstrates ability to communicate clearly through sketching, initiative of pursuing a hobby outside of school
- Architectural sketches/urban sketching preferred
- If this isn't your strong suit, don't include.

Personal Projects – Sketches





An illustration of Santa Maria Novella, mimicking the composition of Urbino's The Ideal City, taking inspiration from The Delivery of the Keys fresco, and using a unique illustrative style. One point perspective was something I really wanted to employ to synthesize Alberti's works of documenting methods of representation of perspective and an architectural work he contributed on into one illustration.

- **Function this serves:** pursuing a hobby outside of school (if not a school project), in this case's illustration, shows off proficiency in Illustrator
- Bonus points for architecture



Shown above: Renders by NBBJ for Coney Island Hospital.

N B B J

CONEY ISLAND HOSPITAL, BROOKLYN
 A hospital expansion/renewal project to rebuild what was destroyed in Hurricane Katrina, with the part of using the oceanfront as a repeated element throughout the hospital. Worked for 75 - 100% Construction Documents. Developed Medical/Specialty Equipment and Power Data Equipment Legends, as well as populating and graphically clarifying plans and elevations.

- **Show off any work you've worked in your co-ops!**
- In larger, corporate firms, this may be just working on Construction Drawings/working sets.
- Don't include working sets in portfolio! Questions of confidentiality/not exciting to look at
 - Unless employer asks to see! (Then redact information)
- You are allowed to put renders of the project even if you did not personally work on them - this is standard in professional world.
- **Be clear you did not work on the renders.**
- Overall, better safe than sorry, ask your employer if you can include firm projects in your portfolio, especially if you're posting it online.

Professional Experience – Large Firm



E C D M

MOSCOU COMPETITION PROJECT

A competition entry for a project located in Moscow, Russia. An attempt to reinvigorate the Simonovskaya Riverside, the proposed project uses elements of the forest as precedent to create a residential-commercial hybrid proposal. The ground, sculpted like the graphic from 'Le Petit Prince', the canopy, with the natural undulations that trees produce, and the sky, with the variation of heights that the forest produces.

Responsibilities included using editing software such as photoshop and illustrator to create and adjust images for final competition submission.

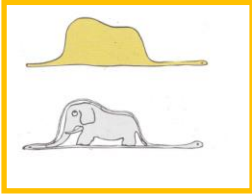

Shown left: Render and section by ECDM for Moscou Competition Project.

- In smaller firms, you will likely be working more intimately with illustrative/competition/visual material
- If you did nice looking work, include it!
- This section in the interview is where you would elaborate on your work experience and skills you acquired in the workplace.
- Example of a successful part: I always get asked about this/there's a discussion about this, very clear!
- Good thing to include to show a synopsis of the project.

Professional Experience – Small Firm



Tips, Tricks & Best Practices:

- Portfolio Curation
- Redoing a Project
- Publishing on Issuu
- Page size & limits
- File size management
- InDesign Tips
- Things to Avoid

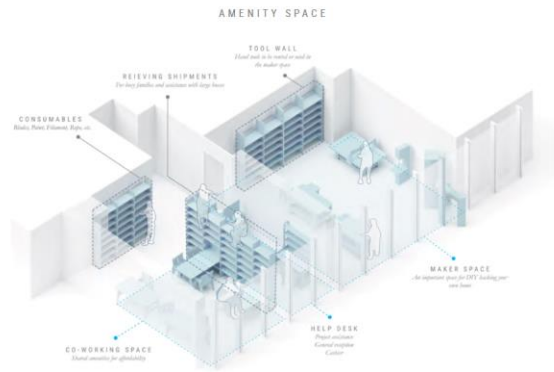
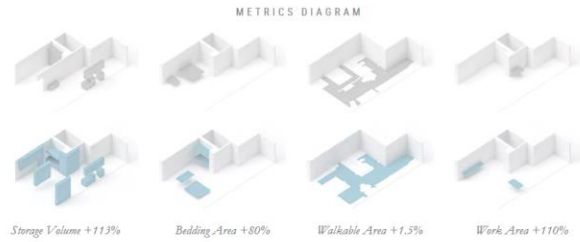

DIY
Unit layouts are hard to change, but families always grow. We believe that there is an opportunity to feel empowered through knowing families assembled and can these disassemble and modify their furniture, to adapt to their needs over time, a right to hack and repair what they own.

METRICS
As architects, drawing is our tool and our medium. As we seek more adaptable and people-centric solutions, part of the project is the exploration of using drawings to construct arguments and the measure impact of our designs.



- Include skills you want to get hired for.
- Tomoki preferred to apply for jobs that prioritized making/fabrication, therefore his portfolio reflects that.
- It's also evident through his portfolio cover!



Tomoki Kaneko's Portfolio

Curate Your Portfolio to Jobs You Want





Node A.



Node C.



Node D.

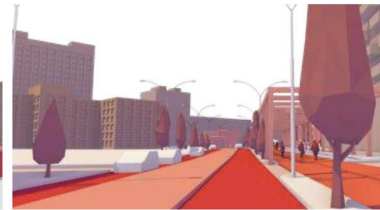

Node D.

An overview of the newly envisioned Victoria Street and the individually programmed nodes, transitioning from a mundane, 4 street traffic through-way to a vibrant, pedestrian oriented path leading to the Civic District.

- You can leverage your architectural skills to pursue other design jobs.
- To get these jobs you don't necessarily need to make a separate portfolio, but you need to be aware of what those employers are looking for (because it's different than architecture)

Curate Your Portfolio to Jobs You Want



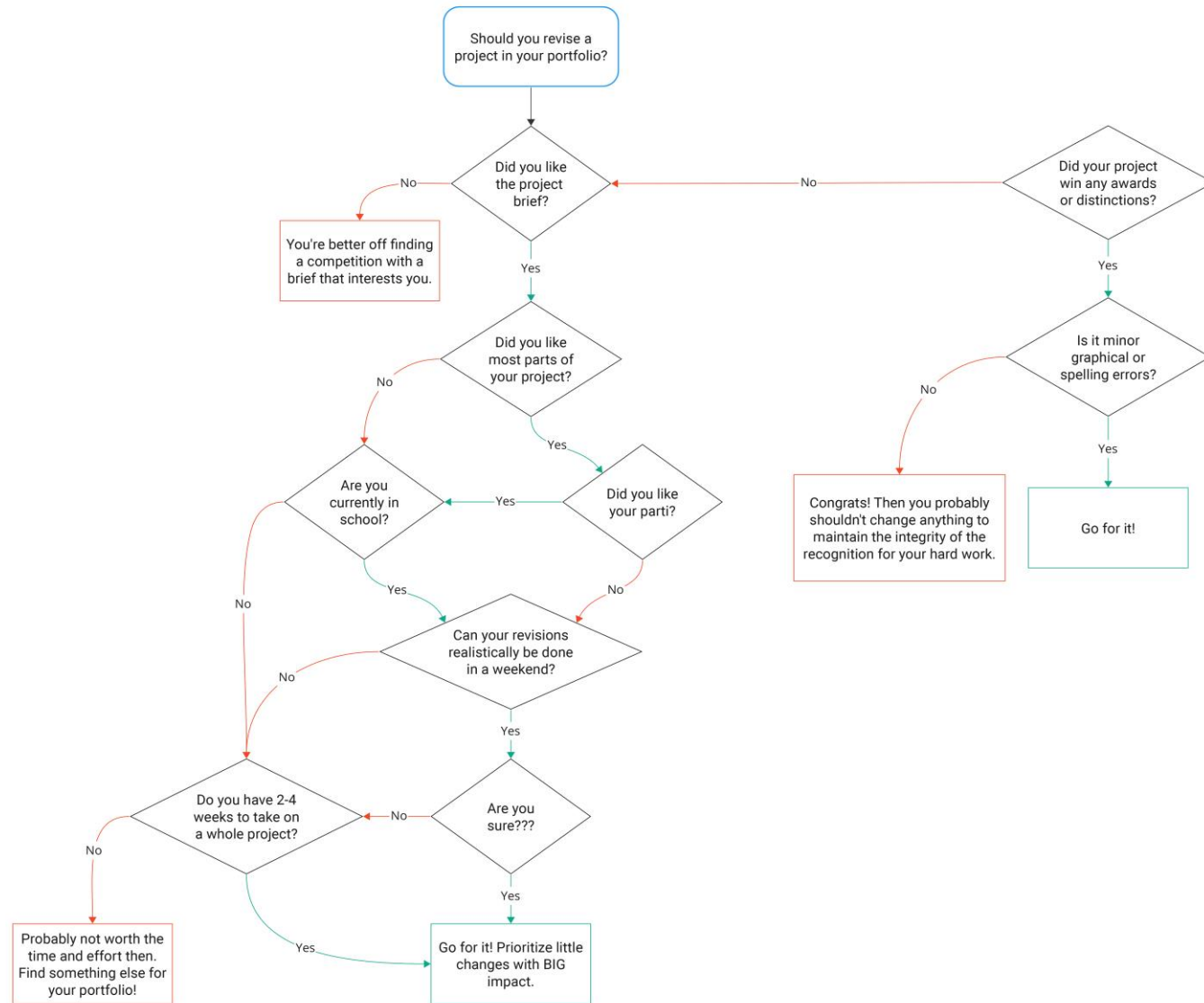

- TL;DR, No, don't do it, it's often not worth it.
- But, if you must, prioritize little changes with big impact
- During the school term, we recommend not redoing a project unless it'll only take a day or two.

To revise or not to revise?



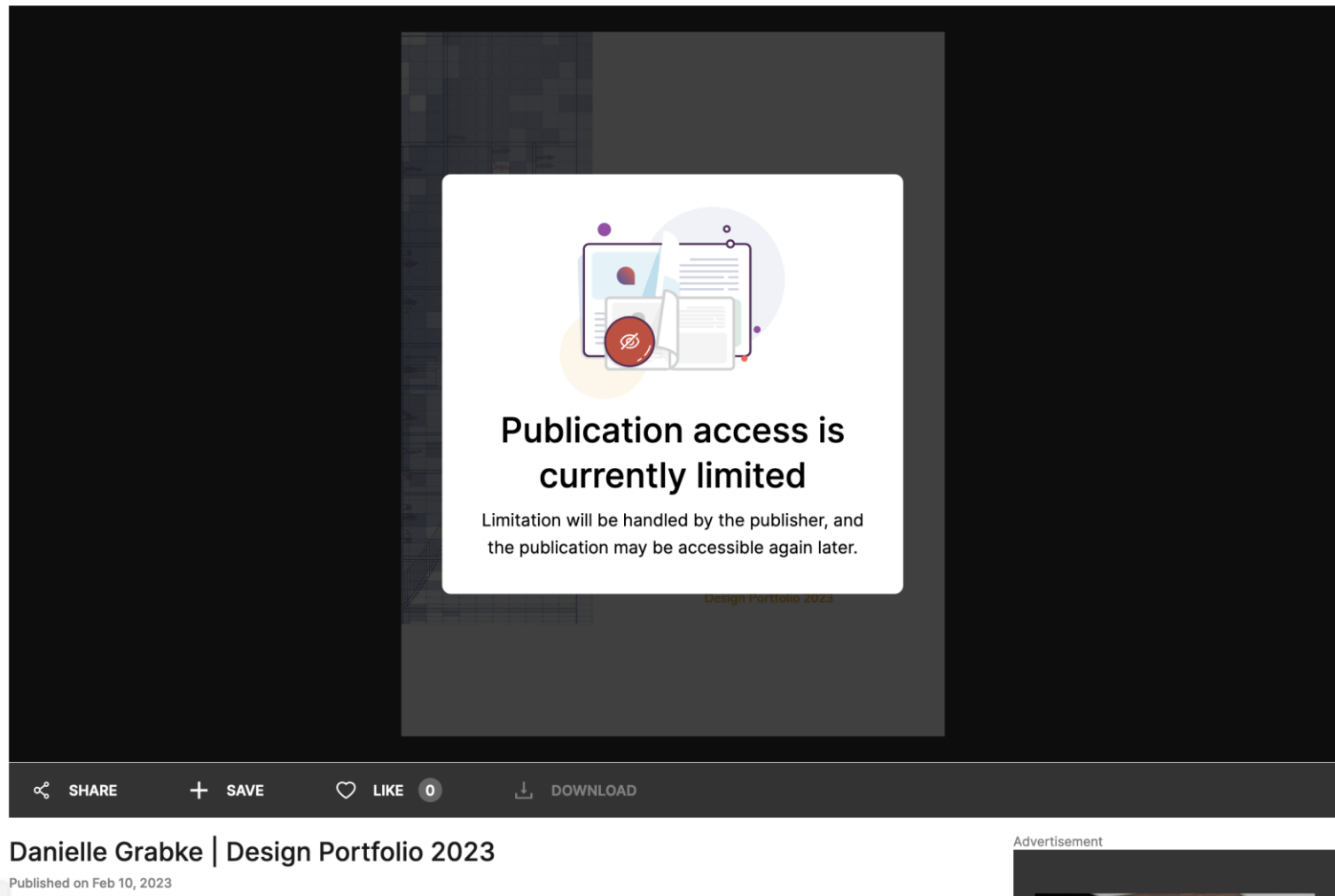

- :(
- A lot of UWSA students post their portfolio on Issuu (but, you'll be met with this error for most uppers years)
- To publish on Issuu, your file must be <50mb and 50 pages max.
- Issuu is a good way to show a higher quality version of your portfolio in a convenient format to share with colleagues/employers.
- Good to add a link to your Issuu in your cover letter and resume!

Publishing on Issuu



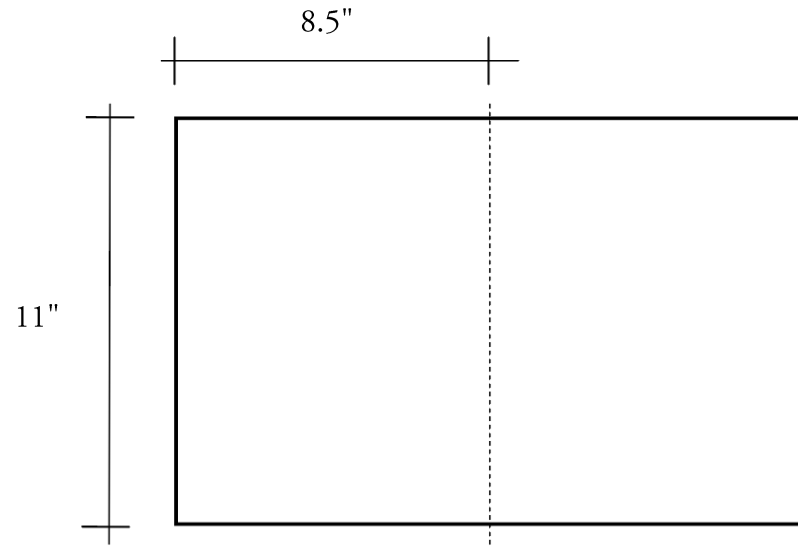

Traditional Portfolio, can be printed on
tabloid

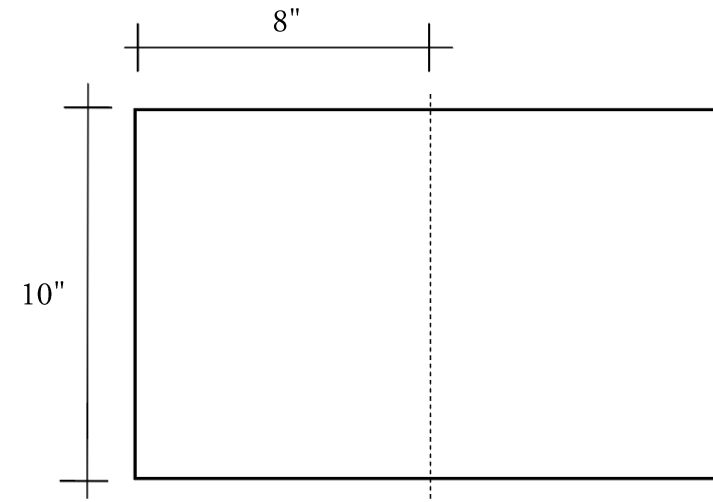

8:10, good for Mac screens and iPads

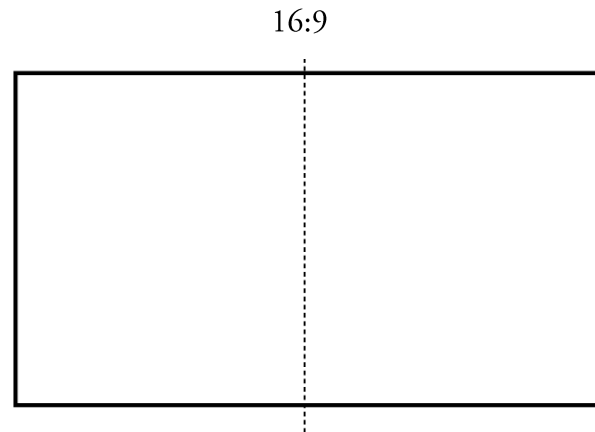

16:9, dimension good for PC screens

Portfolio Dimension

~ 6 projects total

Academic

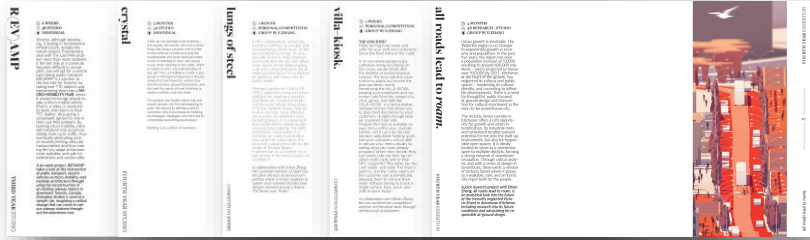

Professional / Personal

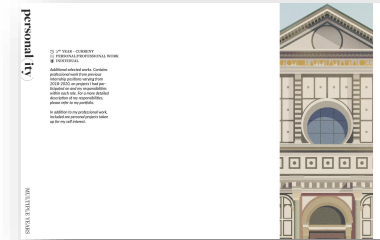

~3-5 spreads each

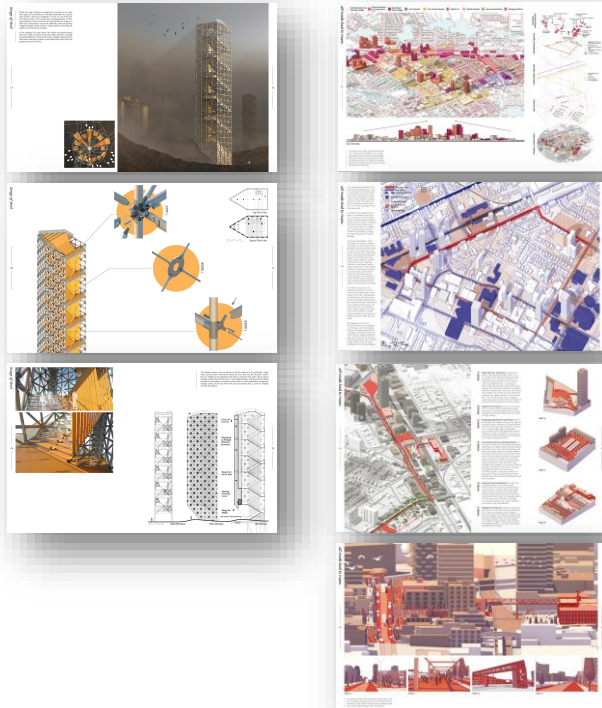

~1-2 spreads each

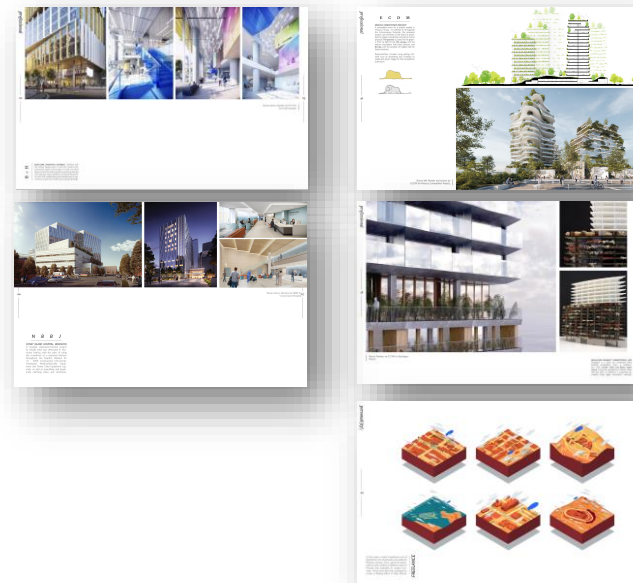

~1 spread each

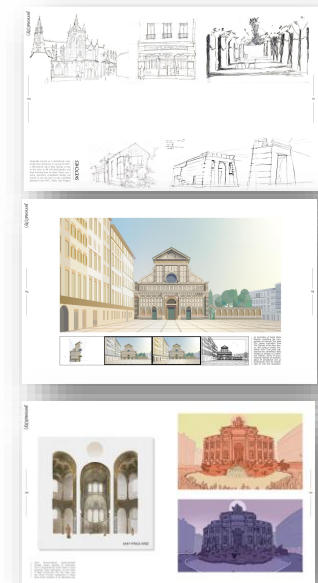

Page suggestions

Magdalena total page count: 67 pages



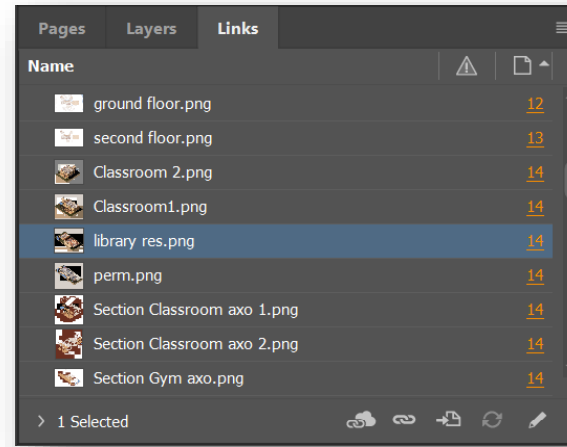

- Might go without saying...
- Save all your images, diagrams, drawings to jpg or png before inserting them into your portfolio.
- Automatically flattens the image
- Helps keep the file size down without ruining the quality!

| | | | |
|-------------|---------------------|---------------------|------------|
| hallway | 2021-12-09 11:31 PM | PNG File | 10,080 KB |
| hallway | 2021-12-13 2:41 AM | Adobe Photoshop ... | 118,086 KB |
| library res | 2021-12-11 2:32 AM | PNG File | 3,364 KB |
| library res | 2021-12-11 9:12 PM | Adobe Photoshop ... | 40,579 KB |
| perm | 2021-12-11 2:30 AM | PNG File | 2,946 KB |
| perm | 2021-12-11 2:30 AM | Adobe Photoshop ... | 67,403 KB |

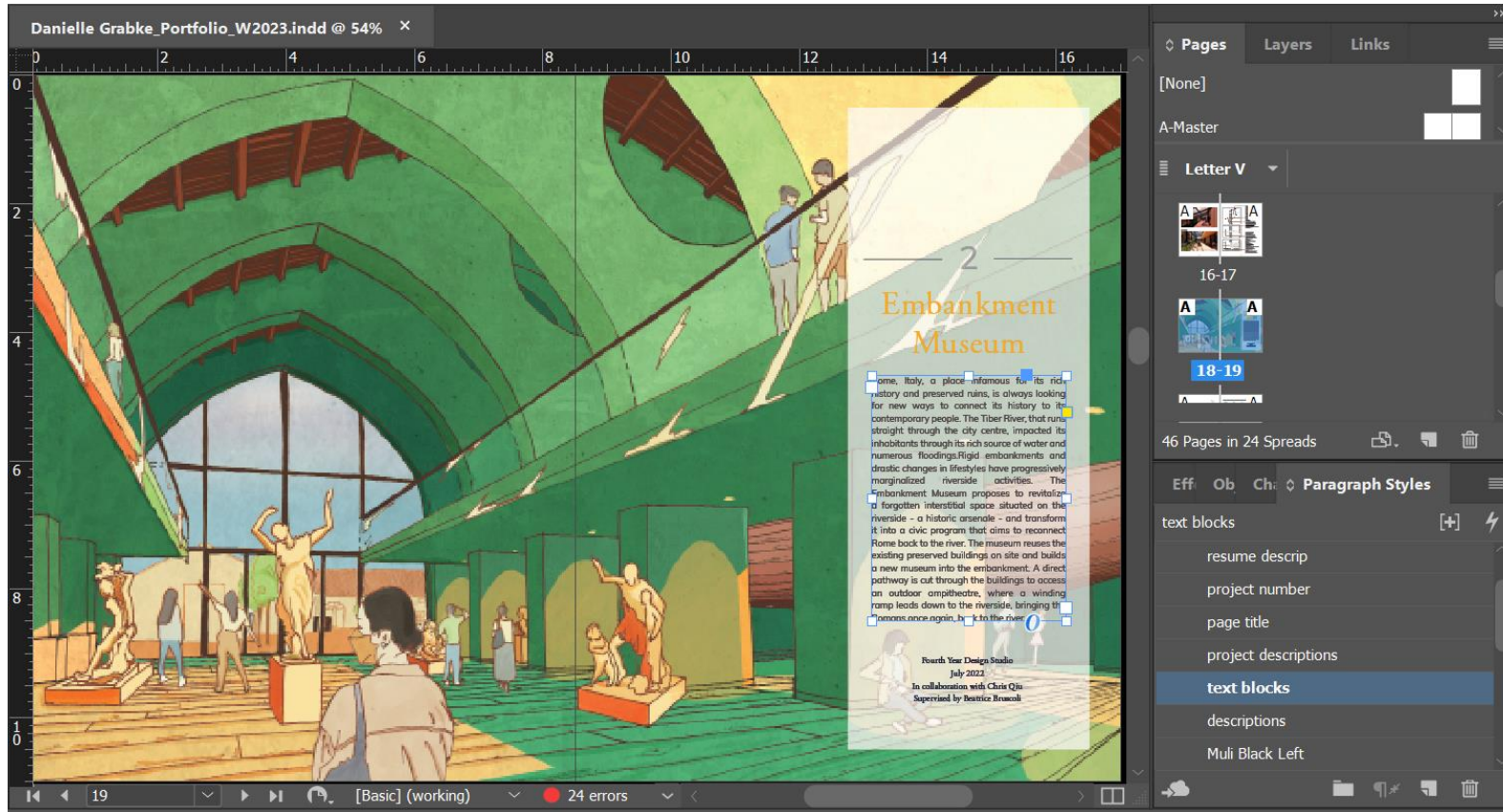

- Always use Paragraph Styles!!
- Keeps your text consistent throughout the portfolio.
- Allows for easy bulk changes without having to search through the document for every instance.
- Allows for easier development over the years.

InDesign: Paragraph Styles



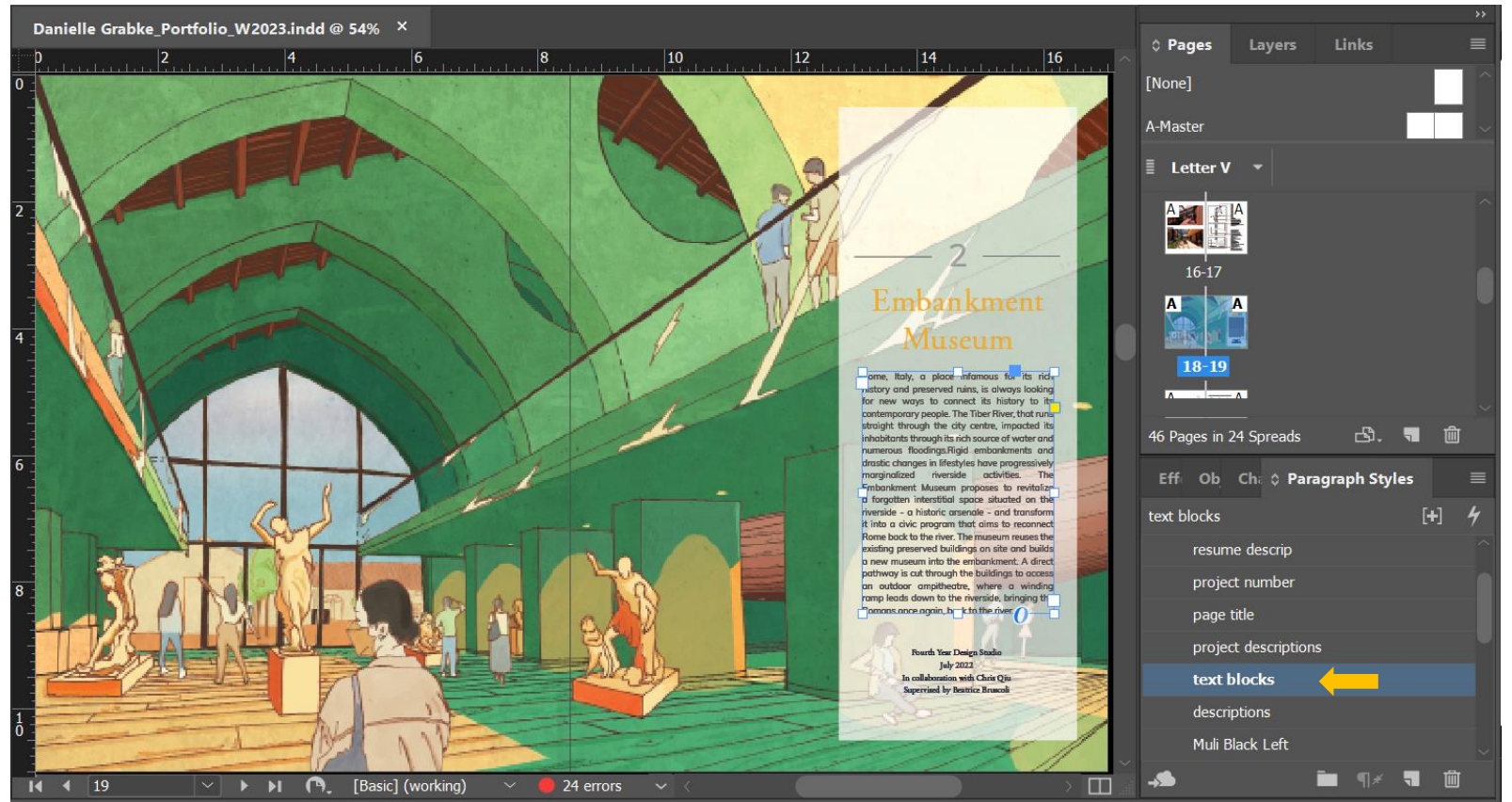

InDesign: Paragraph Styles



The image displays the Adobe InDesign interface with three main components:

- Paragraph Style Options Panel (Left):** A sidebar menu with options such as General, Basic Character Formats, Advanced Character Formats, Indents and Spacing, Tabs, Paragraph Rules, Paragraph Border, Paragraph Shading, Keep Options, Hyphenation, Justification, Span Columns, Drop Caps and Nested Styles, GREP Style, Bullets and Numbering, Character Color, OpenType Features, Underline Options, Strikethrough Options, and Export Tagging. Yellow arrows point to 'Basic Character Formats', 'Hyphenation', and 'Character Color'.
- Basic Character Formats Panel (Top Center):** A configuration window for the 'text blocks' style. It shows settings for Font Family (Muli), Font Style (Regular), Size (10 pt), Leading (14 pt), Kerning (Metrics), Tracking (0), Case (Normal), and Position (Normal). It also includes checkboxes for Underline, Ligatures (checked), No Break, and Strikethrough.
- Document Page (Center):** A page from a book titled 'Embankment Museum'. The page features a colorful illustration of a museum interior with a large number '2' and a text block. The text block is highlighted with a blue selection box.
- Paragraph Styles Panel (Right):** A panel showing a list of paragraph styles. The 'text blocks' style is selected and highlighted in blue. Other styles listed include 'resume descrip', 'project number', 'page title', 'project descriptions', 'descriptions', and 'Muli Black Left'.

InDesign: Paragraph Styles





Shown above: Renders by NBBJ for Coney Island Hospital.

N B B J

CONEY ISLAND HOSPITAL, BROOKLYN
A hospital expansion/renewal project to rebuild what was destroyed in Hurricane Katrina, with the part of using the oceanfront as a repeated element throughout the hospital. Worked for 75 - 100% Construction Documents. Developed Medical/Specialty Equipment and Power Data Equipment Legends, as well as populating and graphically clarifying plans and elevations.

- Graphical Mistakes!
- Spelling errors!
 - InDesign: ctrl/cmd + i for spellcheck

What to avoid:





N B B J

CONEY ISLAND HOSPITAL, BROOKLYN

A hospital expansion/renewal project to rebuild what was destroyed in Hurricane Katrina, with the parti of using the oceanfront as a repeated element throughout the hospital. Worked for 75 - 100% Construction Documents. Developed Medical/Specialty Equipment and Power Data Equipment Legends, as well as populating and graphically clarifying plans and elevations.

N B B J

CONEY ISLAND HOSPITAL, BROOKLYN

A hospital expansion/renewal project to rebuild what was destroyed in Hurricane Katrina, with the parti of using the oceanfront as a repeated element throughout the hospital. Worked for 75 - 100% Construction Documents. Developed Medical/Specialty Equipment and Power Data Equipment Legends, as well as populating and graphically clarifying plans and elevations.

- Text justifying; hot button topic!
- Looks better than non-justified text, but harder to read.
- (My opinion) small paragraphs of text is okay, keep longer text non-justified

What to avoid:



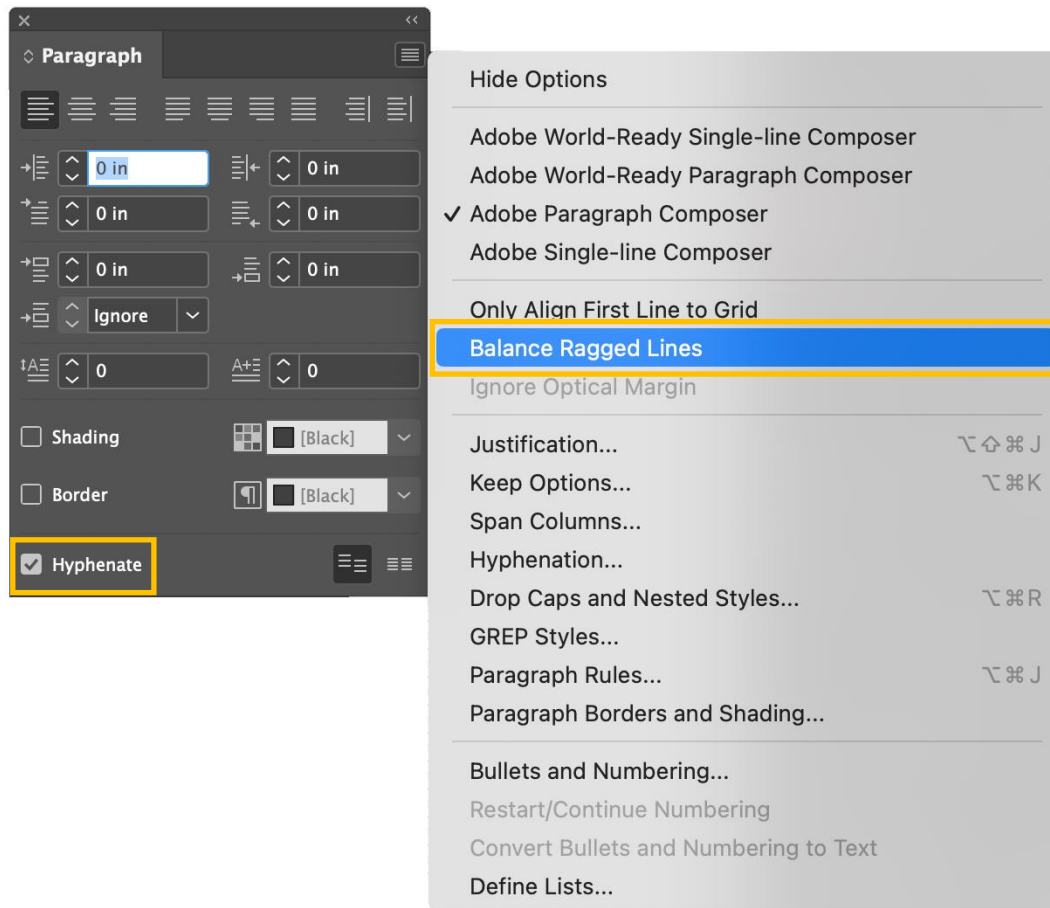

- Option instead of justifying: in 'paragraph' window, select 'balance ragged lines', and have hyphenation on.
- Save this paragraph style to keep consistency throughout portfolio.

What to avoid:

Be intentional!



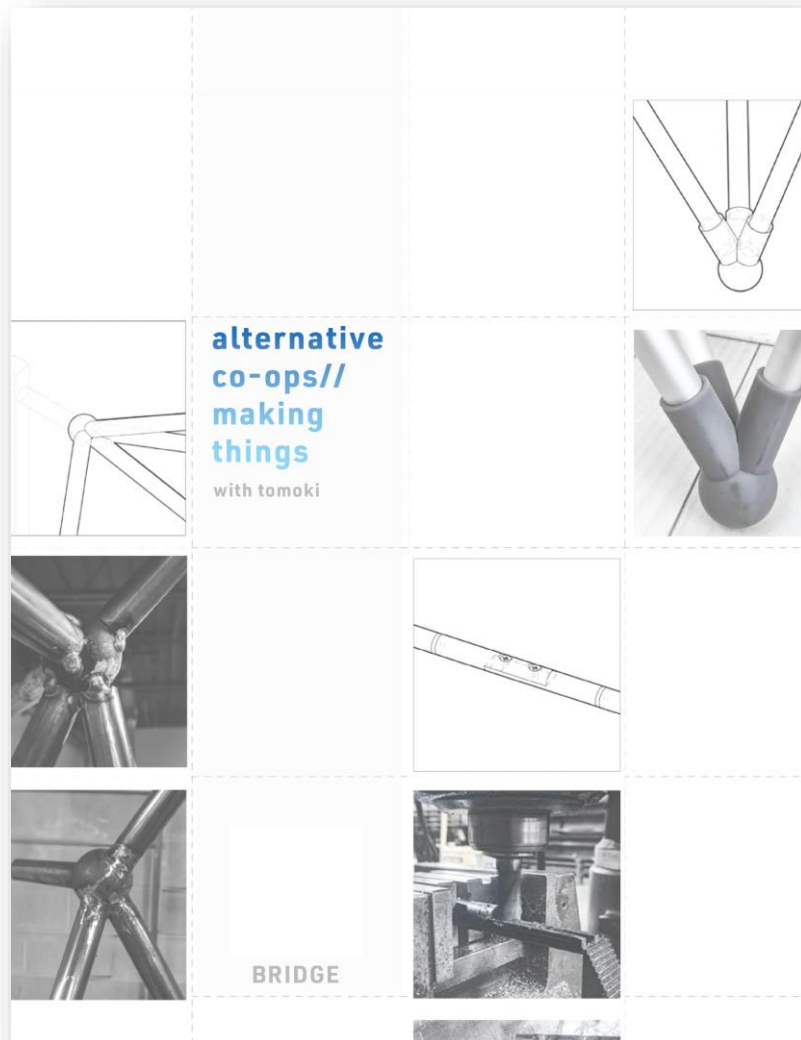

Join Tomoki next week to hear him speak about his non-architecture architecture co-op experiences.

Tuesday, June 27

12:45pm – 1:45pm

In the e-classroom

Thank you! And join us next week!

